

Date	rev.	Description	Sheet
			1

House	P6038-44	Adrian
-------	----------	--------

Drawing	3D	Scale
---------	----	-------

Material	4,4x135	Date	18.02.2016
----------	---------	------	------------

Drawer	RP	File	P6038-44, Adrian 3D.dwg
--------	----	------	-------------------------

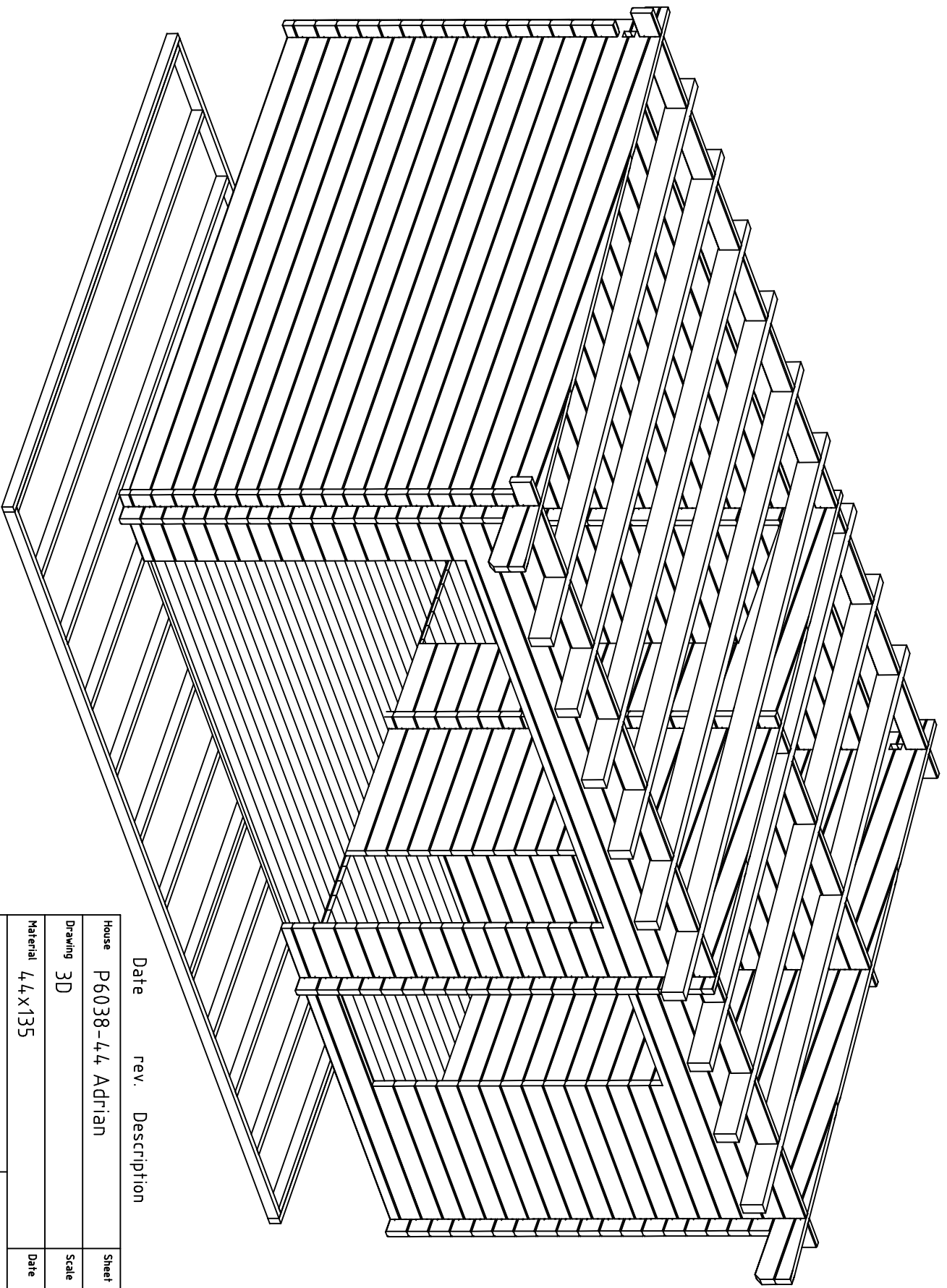

Date	rev.	Description
------	------	-------------

House	P6038-44	Adrian	Sheet	2
-------	----------	--------	-------	---

Drawing	3D	Scale	
---------	----	-------	--

Material	4,4x135	Date	18.02.2016
----------	---------	------	------------

Drawer	RP	File	P6038-44, Adrian 3D.dwg
--------	----	------	-------------------------

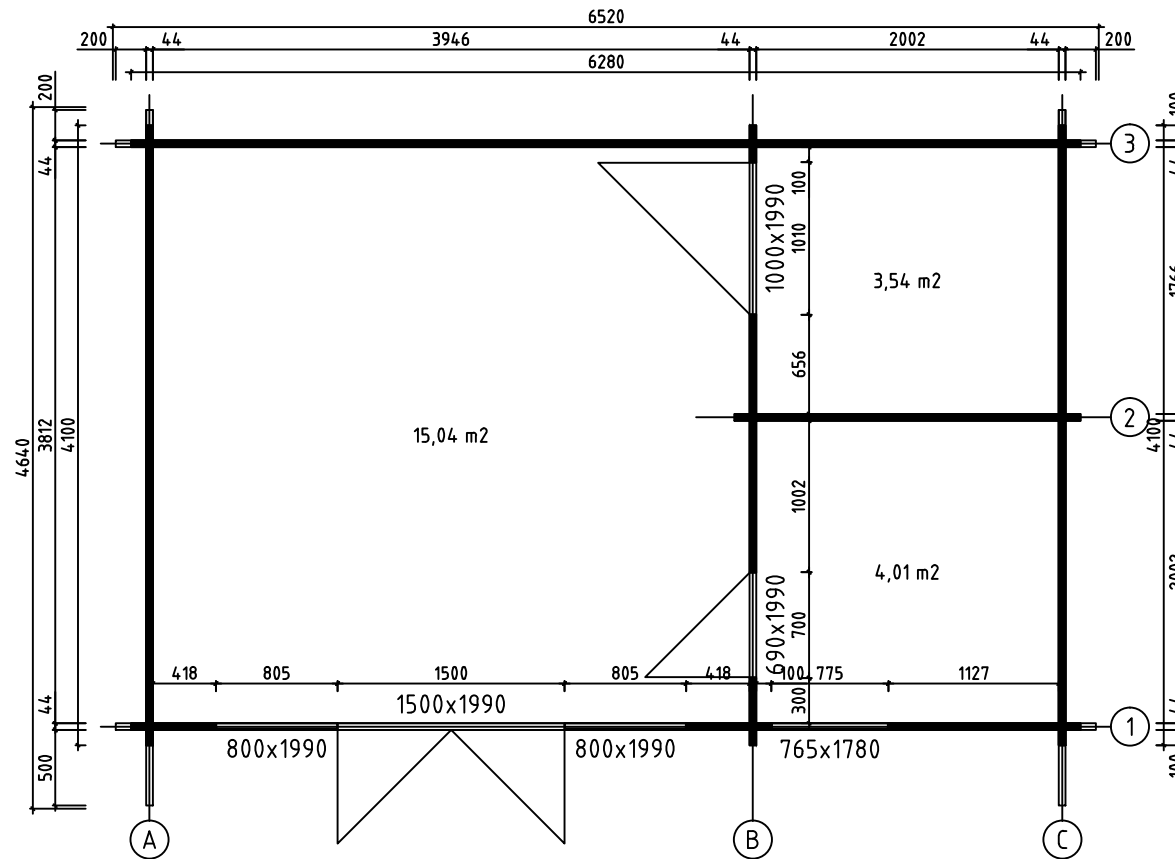

House	P6038-44 Adrian	Sheet	3
Drawing	PLAN-SUUNNITELMA-PLANEN	Scale	1:50
Material	44x135	Date	18.02.2016
Drawer	RP	File	P6038-44 Adrian.dwg

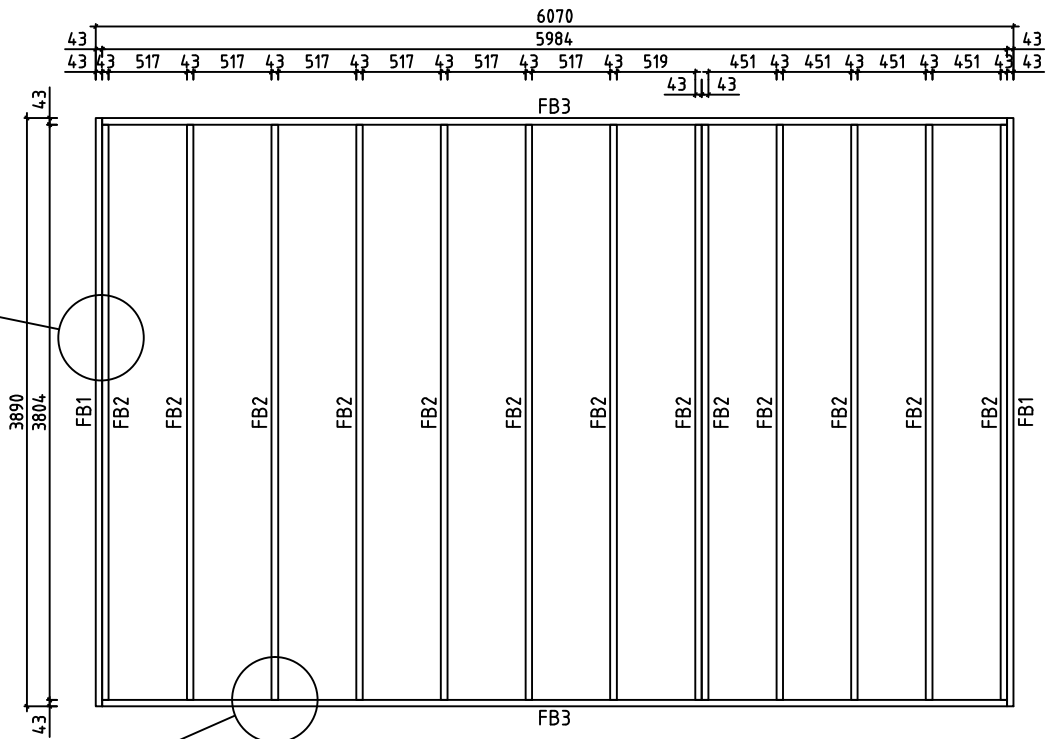
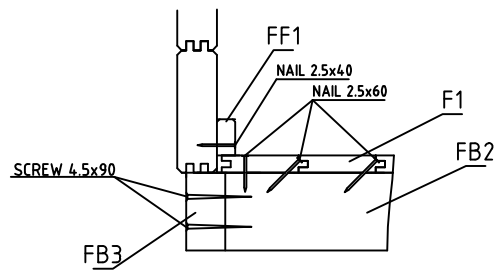
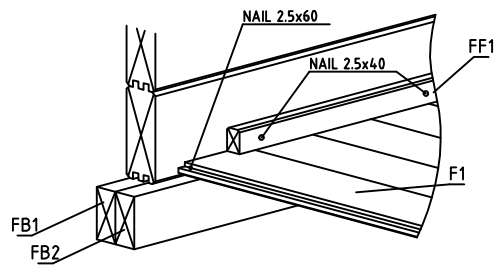

House	P6038-44 Adrian	Sheet	4
Drawing	FLOORBEAMS-LATTIAPALKIT-GOLVBJÄLKAR	Scale	1:50
Material	43x70	Date	18.02.2016
Drawer	RP	File	P6038-44 Adrian.dwg

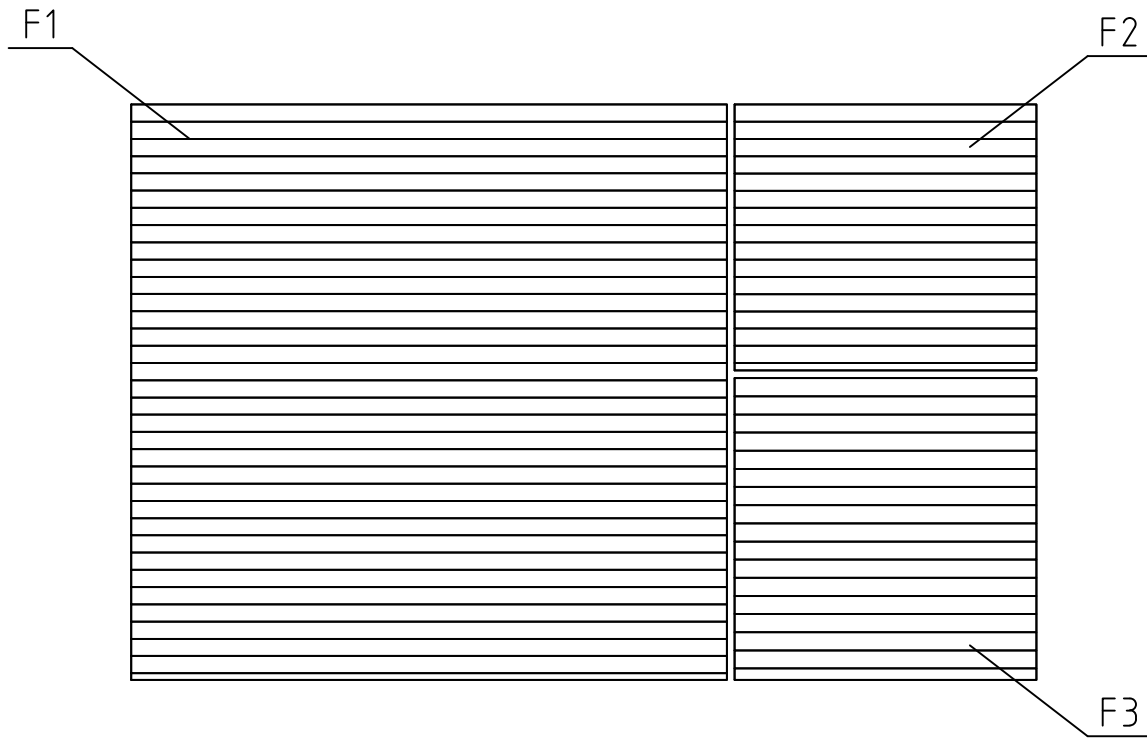

House	P6038-44 Adrian	Sheet	5
Drawing	FLOORBOARD-LATTIALAUTA-GOLVBRÄDE	Scale	1:50
Material	114x19, 120x28	Date	18.02.2016
Drawer	RP	File	P6038-44 Adrian.dwg

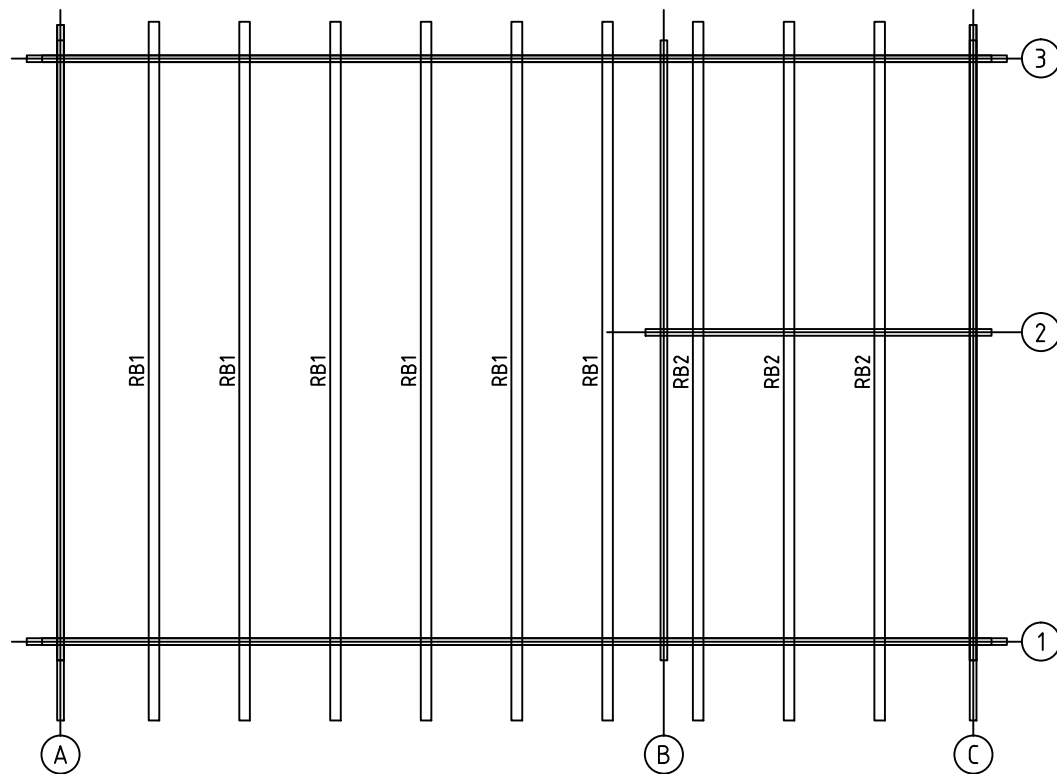

House	P6038-44 Adrian	Sheet	6
Drawing	PURLINS-KATTO-ORRET-TAKÅSAR	Scale	1:50
Material	70x140	Date	18.02.2016
Drawer	RP	File	P6038-44 Adrian.dwg

R1

R2

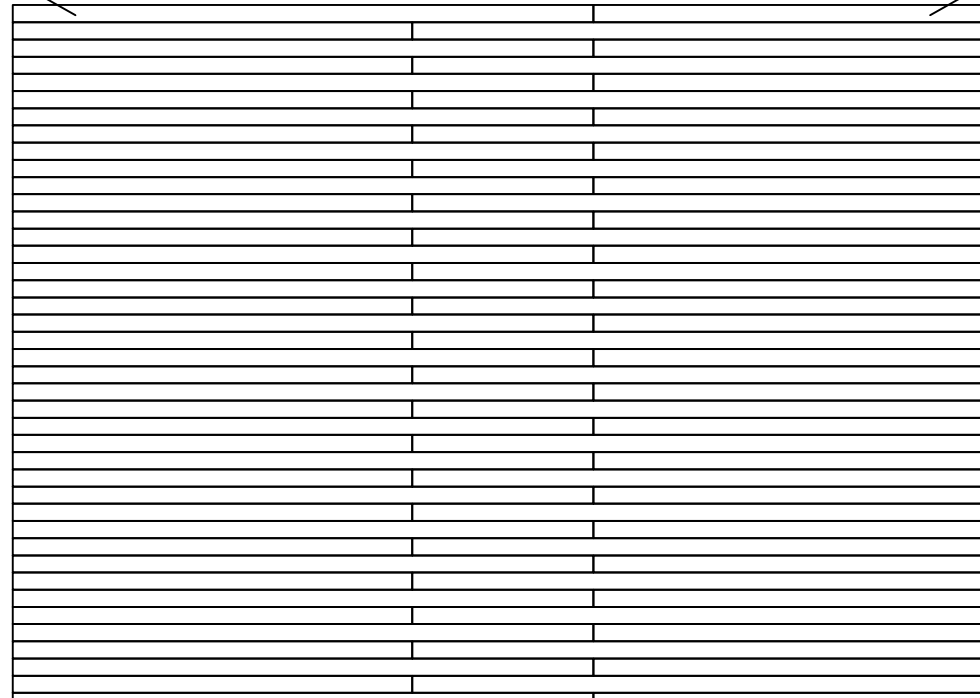

House	P6038-44 Adrian	Sheet	7
Drawing	ROOFBOARD - KATTOLAUTA - TAKBRÄDE	Scale	1:50
Material	114x19	Date	18.02.2016
Drawer	RP	File	P6038-44 Adrian.dwg

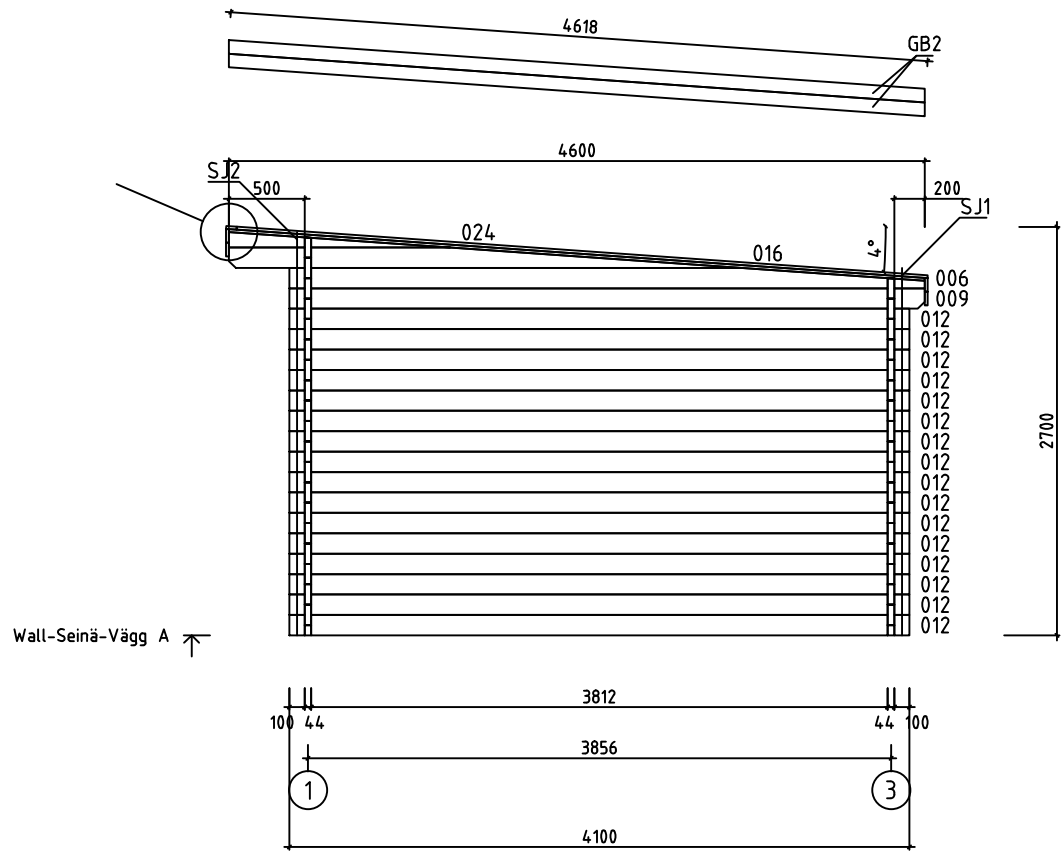
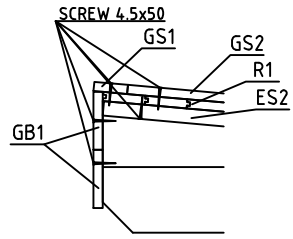

Wall-Seinä-Vägg A ↗

House	P6038-44 Adrian	Sheet	8
Drawing	WALL-SEINÄ-VÄGG A	Scale	1:50
Material	44x135	Date	18.02.2016
Drawer	RP	File	P6038-44 Adrian.dwg

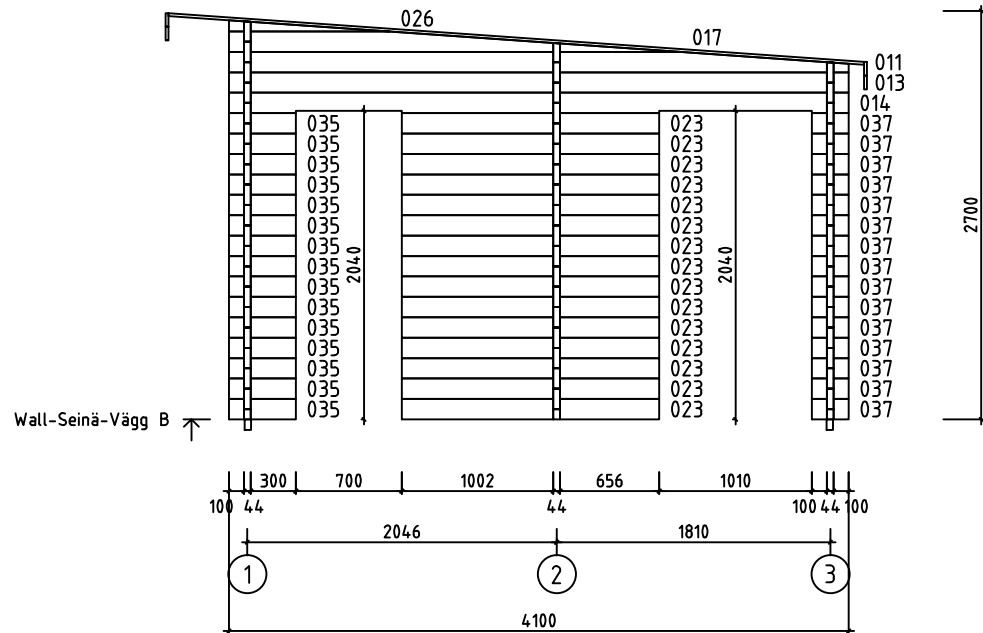

House	P6038-44 Adrian	Sheet	9
Drawing	WALL-SEINÄ-VÄGG B	Scale	1:50
Material	44x135	Date	18.02.2016
Drawer	RP	File	P6038-44 Adrian.dwg

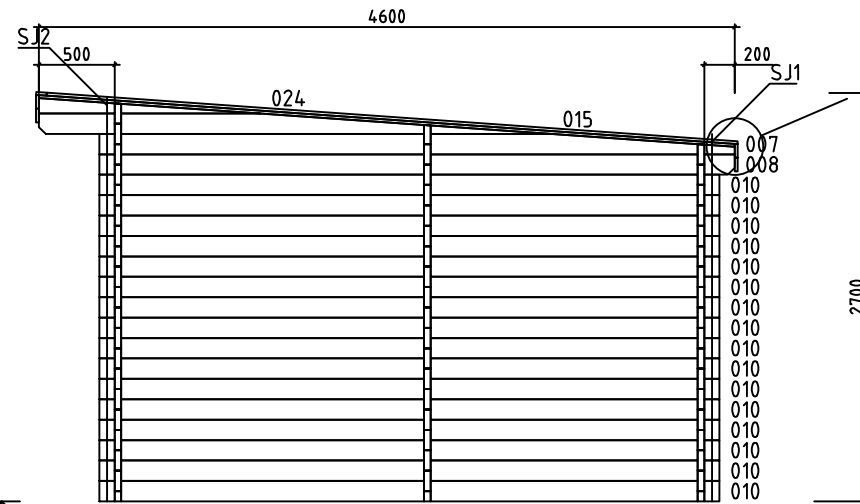
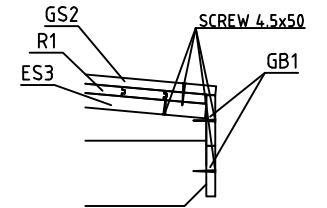

Wall-Seinä-Vägg C ↗

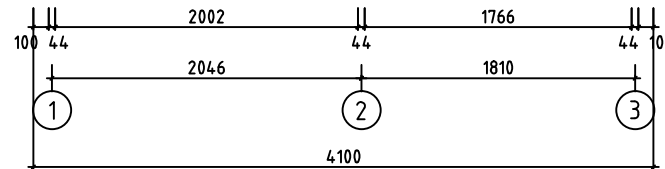

House	P6038-44 Adrian	Sheet	10
Drawing	WALL-SEINÄ-VÄGG C	Scale	1:50
Material	44x135	Date	18.02.2016
Drawer	RP	File	P6038-44 Adrian.dwg

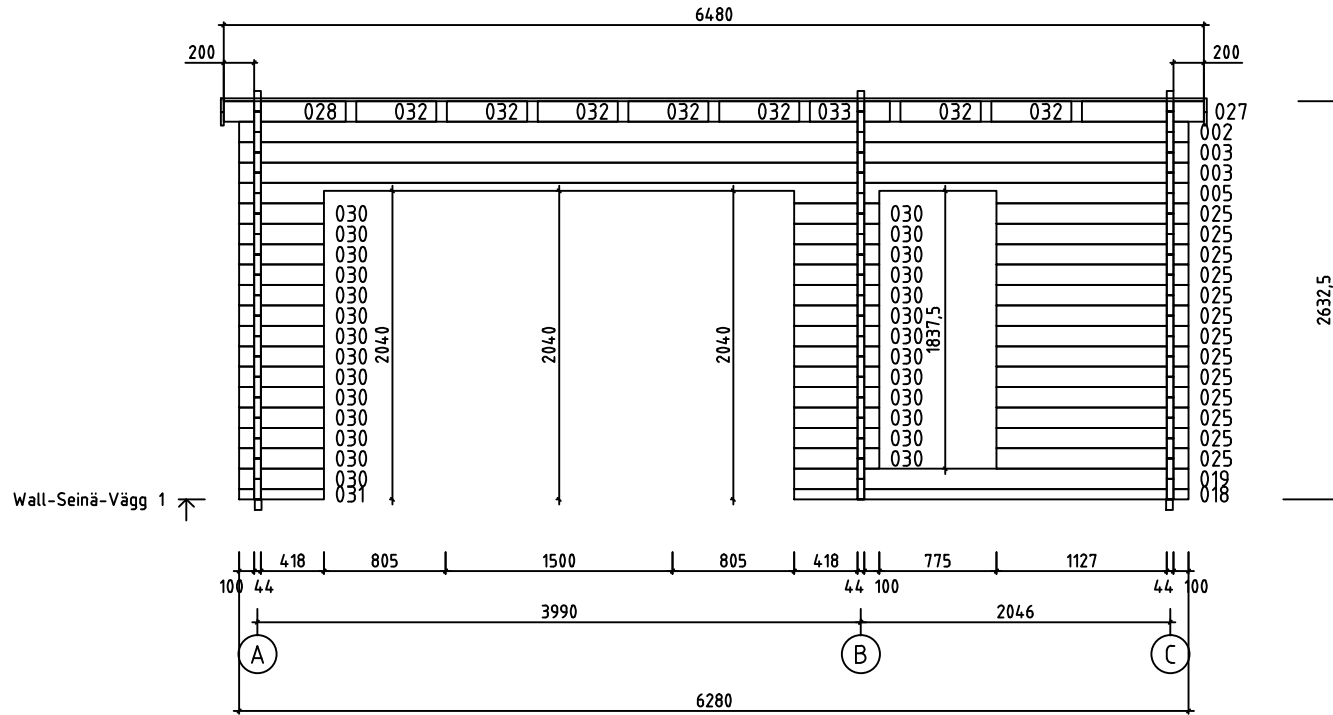
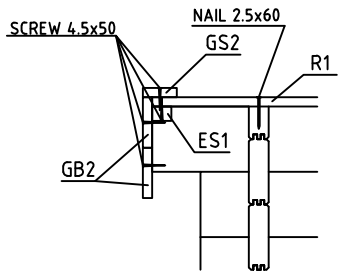

House	P6038-44 Adrian	Sheet	11
Drawing	WALL-SEINÄ-VÄGG 1	Scale	1:50
Material	44x135	Date	18.02.2016
Drawer	RP	File	P6038-44 Adrian.dwg

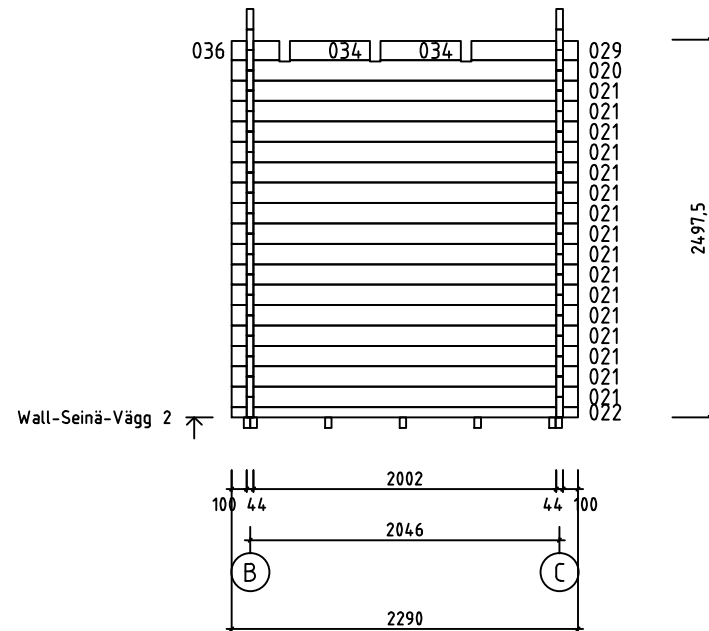



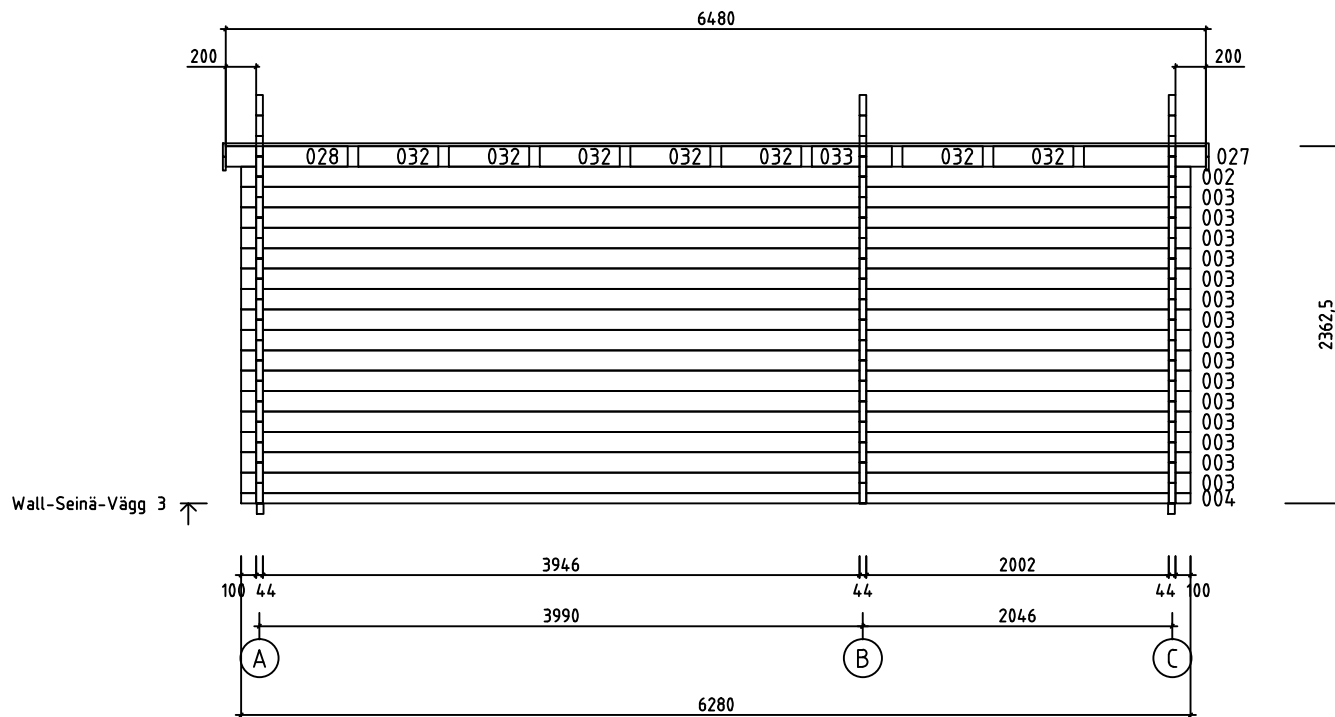





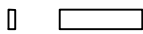



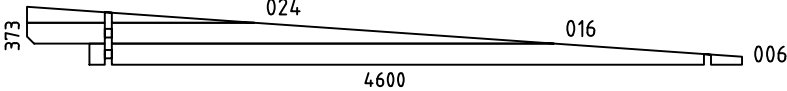
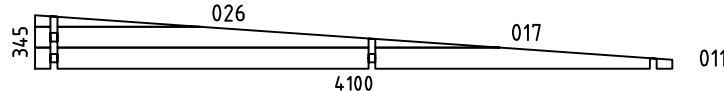
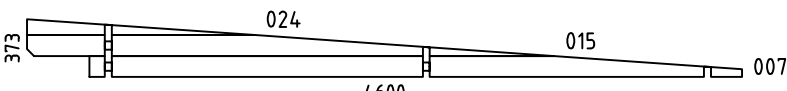







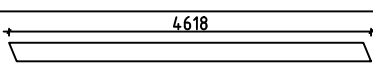





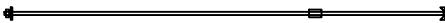

House	P6038-44 Adrian	Sheet	12
Drawing	WALL-SEINÄ-VÄGG 2	Scale	1:50
Material	44x135	Date	18.02.2016
Drawer	RP	File	P6038-44 Adrian.dwg

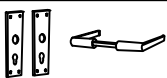

House	P6038-44 Adrian	Sheet	13
Drawing	WALL-SEINÄ-VÄGG 3	Scale	1:50
Material	44x135	Date	18.02.2016
Drawer	RP	File	P6038-44 Adrian.dwg

Pos	P6038-44 Adrian	Pcs. St.	Profil(e) (mm)	L (mm)
001	SPARE BEAM - VARALLAPALKI - RESERVDEL 100 3946 2002 100	1	44x135	6280
002	100 3946 2002 100 PM	2	44x135	6280
003	100 3946 2002 100	17	44x135	6280
004	100 3946 2002 100	1	44x68	6280
005	100 3946 2002 100	1	44x135	6280
008	100 2002 1766 200	1	44x135	4200
009	100 3812 200	1	44x135	4200
010	100 2002 1766 100	16	44x135	4100
012	100 3812 100	16	44x135	4100
013	100 2002 1766 100	1	44x135	4100
014	100 2002 1766 100	1	44x135	4100
018	418 2002 100	1	44x68	2608
019	418 2002 100	1	44x135	2608
020	100 2002 100	1	44x135	2290
021	100 2002 100	16	44x135	2290
022	100 2002 100	1	44x68	2290
023	1002 656	15	44x135	1702
025	1127 100	13	44x135	1271
027	561 200	2	44x135	805
028	200 561	2	44x135	805
029	561 100	1	44x127	705
030	418 100	27	44x135	562
031	100 418	1	44x68	562
032		14	44x135	530
033	315 171	2	44x135	530
House P6038-44 Adrian		Material	File P6038-44 Adrian.dwg	Sheet 14

Pos	P6038-44 Adrian		Pcs. St.	Profil(e) (mm)	L (mm)
034			2	44x127	530
035			15	44x135	444
036			1	44x127	315
037			15	44x135	244
WA-1			1	44x373	4600
WB-1			1	44x345	4100
WC-1			1	44x373	4600
HB	HIT BLOCK-ASENNUSPALKI-SLAG BRÄDA		2	44x135	300
FB3	FLOORBEAMS - LATTIAPALKIT - GOLVBJÄLKAR		2	43x70	5984
FB1	FLOORBEAMS - LATTIAPALKIT - GOLVBJÄLKAR		2	43x70	3890
FB2	FLOORBEAMS - LATTIAPALKIT - GOLVBJÄLKAR		13	43x70	3804
RB1	PURLINS - KATTO - ÖRRET - TAKASAR		6	70x140	4621
RB2	PURLINS - KATTO - ÖRRET - TAKASAR		3	70x140	4621
F1	FLOORBOARD - LATTIALAUTA - GOLVBRÄDE	 114 or-tai-eller 88	34+1 44+1	114x19 88x19	3940
F2	FLOORBOARD - LATTIALAUTA - GOLVBRÄDE	 114 or-tai-eller 88	16+1 21+1	114x19 88x19	1995
F3	FLOORBOARD - LATTIALAUTA - GOLVBRÄDE		17+1	120x28	1995
R1	LOFT BOARD - PARVIALATTIA - LOFTGOLV	 114 or-tai-eller 88	41+1 54+1	114x19 88x19	3840
R2	ROOFBOARD - KATTOLAUTA - TAKBRÄDE	 114 or-tai-eller 88	41+1 54+1	114x19 88x19	2640
FF1	SKIRTING SLAT - LATTIALISTA - GOLVLIST			19x35	32 m
GB1	GABLE BOARD - KAAPELILAUTA - GAVELBRÄDA		8	19x90	3260
GB2	GABLE BOARD - KAAPELILAUTA - GAVELBRÄDA		4	19x90	4618
GS1	BOARD MATCHING WITH GABLE BOARD-KAAPELILAUTA VASTAVA LAUTA-BRÄDA OVANPÅ GAVELBRÄDA		2	19x70	3260
House	P6038-44 Adrian	Material	File	P6038-44 Adrian.dwg	Sheet 15

Pos	P6038-44 Adrian		Pcs. St.	Profil(e) (mm)	L (mm)	
GS2	BOARD MATCHING WITH GABLE BOARD-KAAPELILAUTA VASTAVA LAUTA-BRÄDA OVANPÅ GAVELBRÄDA		2	19x70	4580	
ES1	EAVE SLAT - RÄYSTÄSLISTA - TAKFOTLIST		2	30x40	3820	
ES2	EAVE SLAT - RÄYSTÄSLISTA - TAKFOTLIST		2	30x40	500	
ES3	EAVE SLAT - RÄYSTÄSLISTA - TAKFOTLIST		2	30x40	200	
SJ1	SCREW JOINT-KIERRETANKO-GÄNGSTAPP		2	ØM10	2380	
SJ2	SCREW JOINT-KIERRETANKO-GÄNGSTAPP		2	ØM10	2670	
	NAILS-NAULAT-SPIKAR FOR-VARTEN-FÖR	FF1		70	Ø2.0	40
	NAILS-NAULAT-SPIKAR FOR-VARTEN-FÖR	F1, F2, F3, R1, R2		1250	Ø2.5	60
	SCREWS-RUUVIT-SKRUVAR FOR-VARTEN-FÖR	GB1, GB2, GS1, GS2, ES1, ES2, ES3		120	Ø4.5	50
	SCREWS-RUUVIT-SKRUVAR FOR-VARTEN-FÖR	004, 018, 022, 031 FB1, FB2, FB3		80	Ø4.5	90
	SCREWS-RUUVIT-SKRUVAR FOR-VARTEN-FÖR	027, 028, 029, 032, 033, 034, 036 RB1, RB2		70	Ø6.0	160
	DOOR HANDLE-OVEN KAHVA-DÖRR HANDTAG FOR-VARTEN-FÖR	D1, D2		2		
	DOOR LOCK+KEYS-OVENLUKKO+AVAIN-DÖRRLAS+NYCKLAR FOR-VARTEN-FÖR	D1, D2		2		
	DOOR HANDLE-OVEN KAHVA-DÖRR HANDTAG FOR-VARTEN-FÖR	D3		1		
	DOUBLEDORR FRAME SET FOR-VARTEN-FÖR	D1		1		
House	P6038-44 Adrian	Material	File	P6038-44 Adrian.dwg	Sheet	16

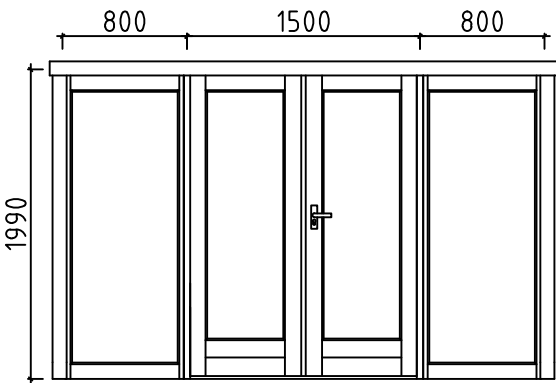
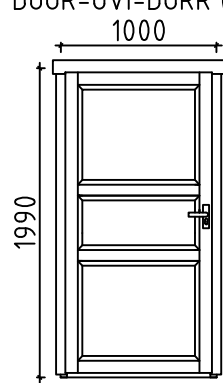
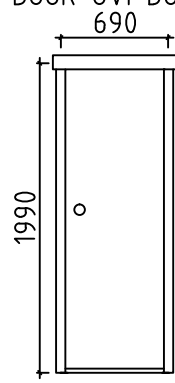
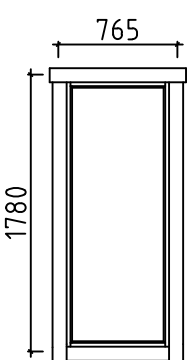
Pos	P6038-44 Adrian	Pcs. St.	Profil(e) (mm)	L (mm)
D1 W1	DOOR-OVI-DÖRR (right-oikea-höger) ORT_ST 	P 1 2	1500 800	1990 1990
D2	DOOR-OVI-DÖRR (left-jäljellä-vänster) AST 	V 1	1000	1990
D3	DOOR-OVI-DÖRR (right-oikea-höger) 	P 1	690	1990
W1	WINDOW-IKKUNAN-FÖNSTER ORT_ST_K 	1	765	1780
House P6038-44 Adrian		Material	File P6038-44 Adrian.dwg	Sheet 17

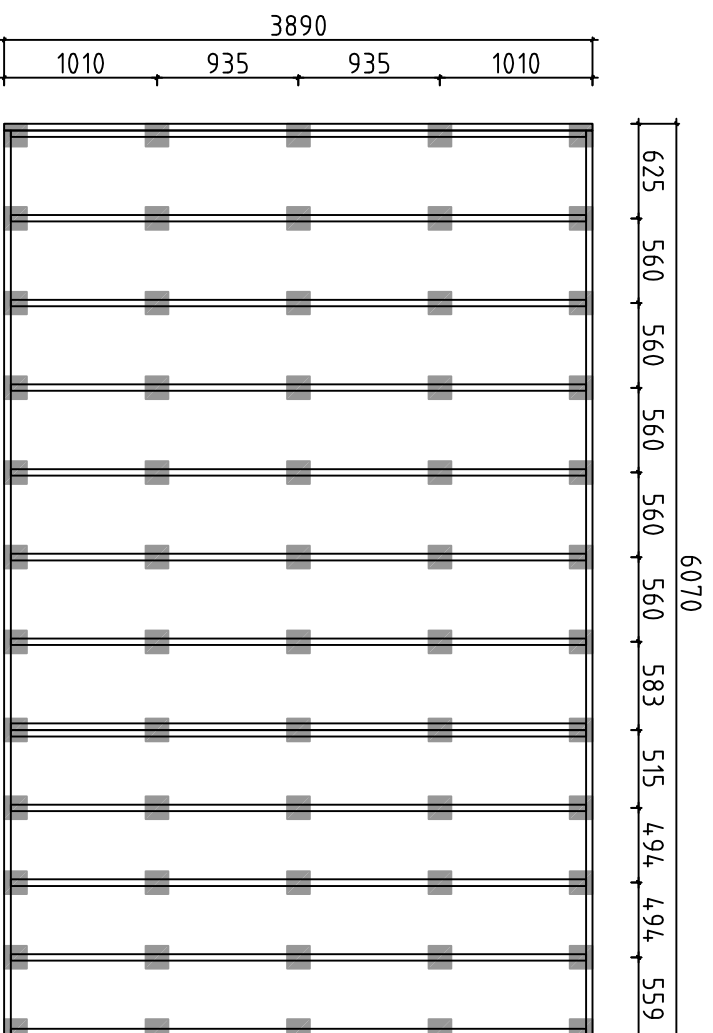

Detta är ett förslag för hur man kan placera plintarna (100-200 mm i diameter) för golvbjälklaget. Golvbjälkarna är med i byggsatsen, men inte plintarna. Använder man exempelvis 500-600mm långa murblock så kan man halvera antalet punkter. Lägg fuktskyddande papp mellan betong och trä

Tälmä on ehdotus siitä, miten (100-200 mm läpimittaiset) jalat voidaan sijoittaa alapohjan varten. Lattiapalkit ovat rakennussarjassa, mutta jalat ei ole. Kun käytetään esimerkiksi 500-600 mm pitkiä harkkoja, voidaan pisteiden määrä puoltaa. Aseta betonin ja puun väliin kosteudelta suojava pahvi

A proposal for placing plinths (100-200 mm in diameter) for floor beams. Floor beams are provided in the kit but plinths are not included. For example, by using 500-600 mm long masonry units, one can reduce the number of points 50%. Place cardboard between the concrete and wood to protect from moisture

House	P6038-44 Adrian	Sheet	18
Drawing	FOUNDATION PLAN - PLINTPLAN	Scale	1:50
Material		Date	18.02.2016
Drawer	RP	File	P6038-44, Adrian Foundation.dwg

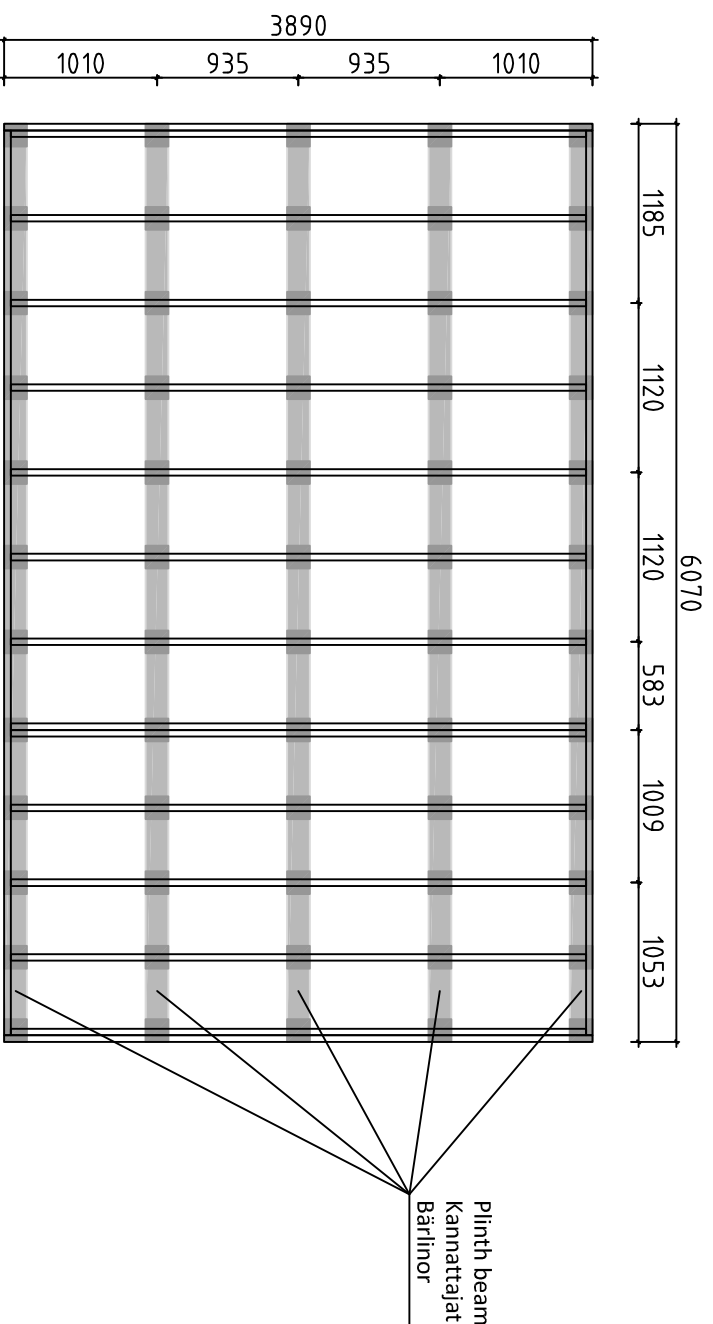

Förslag på alternativ plintplan med bärlinor och plintar. Bärlinor 45x95 eller 45x120 och plintar ca 100-200 mm i diameter. (Bärlinor och plintar ingår ej i leveransen). Används exempelvis murblock, (ingår ej i leveransen) istället för plintar, kan man lägga bärlinorna platt mot dessa och på det sättet minska höjden på konstruktionen. I denna konstruktion kan man dessutom lägga en "boardskiva" mellan bärlinorna och golvbjälkarna och på det sättet bära upp bjälklagsisoleringen. Lagg fuktskyddande papp mellan betong och trä

Endotus valtoehtoisestä jalustasta kannattajilla ja jalolla. Kannattajat 45x95 tai 45x120 ja jalat läpimitataan n. 100-200 mm (kannattajia ja jalkoja ei ole toimituksessa). Käytettäessä esimerkiksi harkkoja (ei kuulu toimitukseen) jalkojen sijasta, voi kannattajat asettaa lappeelleen niitä vasten ja sillä tavoin vähentää rakenteen korkeutta. Tässä rakenteessa voi lisäksi asettaa levyn kannattajien ja lattiapalkkien väliin ja sillä tavoin kannattaa alapohjan eristystä. Aseta betonin ja puun väliin kosteudelta suojaava pähvi

A proposal for alternative plinth beam layout plan. Plinth beams 45x95 or 45x120 and plinths ca 100-200 mm in diameter (plinth beams and plinths are not included in the kit). For example, by using masonry units (not included in the kit) instead of plinths, one can lay plinth beams flat against the masonry units and in that way reduce the height of the structure. In this construction one can also add "plywood board" between plinth beams. Place cardboard between the concrete and wood to protect from moisture

House	P6038-44 Adrian	Sheet	19
Drawing	FOUNDATION PLAN - PLINTPLAN	Scale	1:50
Material		Date	18.02.2016
Drawer	RP	File	P6038-44 Adrian Foundation.dwg

#001		6280	1
#002	1,3	6280	2
#003	1,3	6280	17
#004	3	6280	1
#005	1	6280	1
#006	A	4200	1
#007	C	4200	1
#008	C	4200	1
#009	A	4200	1
#010	C	4100	16
#011	B	4100	1
#012	A	4100	16
#013	B	4100	1
#014	B	4100	1
#015	C	3392	1
#016	A	3392	1
#017	B	2992	1
#018	1	2608	1
#019	1	2608	1
#020	2	2290	1
#021	2	2290	16
#022	2	2290	1
#023	B	1702	15
#024	A,C	1464	2
#025	1	1271	13
#026	B	1064	1
#027	1,3	805	2
#028	1,3	805	2
#029	2	705	1
#030	1	562	27
#031	1	562	1
#032	1,3	530	14
#033	1,3	530	2
#034	2	530	2
#035	B	444	15
#036	2	315	1
#037	B	244	15