

# OPERATING INSTRUCTIONS

## MOOVER



MOOVER

[www.MOOVER.eu](http://www.MOOVER.eu)  
V\_01 / REVISION: 14. 08. 2023 / EN

**Convenient and easy to operate by remote control.** THE MOOVER can be installed by yourself and solar power ensures that the battery will not run down in the season.



# Contents

## - MOOVER operating instructions

<b>General Information</b> .....	<b>02</b>
<b>Included with the Delivery</b> .....	<b>03</b>
<b>MOOVER's Principle of Operation</b> .....	<b>04</b>
<b>Stacking System Operating Principle</b> .....	<b>05</b>
<b>Preparations Before Installation</b> .....	<b>06</b>
<b>Installing the Stacking System</b> .....	<b>08</b>
<b>MOOVER Preparation Before Installation</b> .....	<b>12</b>
<b>MOOVER Installation</b> .....	<b>15</b>
<b>Pairing the Remote Control</b> .....	<b>20</b>
<b>LED Panel Animation</b> .....	<b>21</b>
<b>MOOVER Maintenance Instructions</b> .. ..	<b>22</b>
<b>What to do if...</b> .....	<b>24</b>
<b>Detailed Specifications and Liability for Defects</b> .....	<b>26</b>
<b>Charging Process and Principle</b> .....	<b>27</b>
<b>Replacing the Battery</b> .....	<b>28</b>
<b>Replacing Fuses</b> .....	<b>30</b>
<b>List of Connectors</b> .....	<b>31</b>
<b>Preparing the Enclosure Before Using the Moover Electric Sliding System</b> .....	<b>32</b>

Thank you for purchasing the MOOVER electric drive for pool enclosures.

We have listened to you, and we have looked at the existing solutions the market has to offer, all with a clear goal – to offer the best way to automatically set your pool enclosure in motion. THE MOOVER is quiet and smooth in operation; it is remotely controlled and solar-powered. Its installation is easy enough that you can mount it yourself (although we strongly recommend using a professional company) onto any new or existing standard enclosure, except enclosures with a negative side surface angle. For custom enclosures, it is necessary to fix 1063-mm pitch screws to the support profiles or solid side surface. If the enclosure design does not meet this requirement, THE MOOVER cannot be installed! For single-side rail enclosures, always install THE MOOVER on the track side. We do not recommend mounting it on any no-line enclosure.

These operating instructions provide information on the operation and maintenance of the MOOVER electric drive for pool enclosures. All the information provided in this edition of the manual is based on the latest knowledge and product data available at the time of publication. ALBIXON a.s. reserves the right to make changes at any time without prior notice without this extending the scope of its responsibilities. No part of this edition of the manual may be reproduced without the written consent of ALBIXON a.s. or its exclusive dealer. These instructions should be seen as part of the electric drive and should be kept with the product if it is resold.

The MOOVER electric drive for pool enclosures is designed to guarantee safe and reliable operation when the instructions below are followed. **Before putting the electric drive into operation, read this manual carefully and familiarize yourself with the proper operation of the device** to prevent serious injury or damage to the enclosure. Any failure to observe the maintenance and operating guidelines specified in the operating instructions, not using original spare parts and accessories or any tampering will void the warranty.

# General Information

## - instructions, installation and use

**This manual contains instructions for the safe installation, commissioning and actual use of the MOOVER electric drive. The manual shows the only correct procedure for installation by the user.** Should you have any questions regarding the installation or find any ambiguities in the manual, please contact the [manufacturer](#). Occupational health and safety regulations must be observed during installation (e.g. using gloves, goggles, etc.). Any modification or removal of original MOOVER components is not permitted. During installation and commissioning, make sure that all MOOVER components are properly mounted in their place and that there are no other persons or objects in the travel path that could collide with the sliding assembly. The surface under the MOOVER wheel must be clean, smooth and horizontal (flatness + - 2 mm per 2 m). The electric drive is only able to overcome an obstacle on the pad in the travel path with a height of +/- 8 mm. For obstacles with a greater height, the correct travel functionality can no longer be guaranteed. Surge protection ensures that the device is switched off in the event of contact with an obstacle – however, it does not prevent a collision with an obstacle. The behaviour of the product may vary depending on ambient conditions, which may differ from those during installation.

For the MOOVER to function properly, you must have a stacking system installed. If you do not have this system as part of your enclosure, it must be installed before the MOOVER is commissioned. The installation parts are sold as separate accessories. The exact installation procedure is described in the chapter "Installing the Stacking System".

**The MOOVER must not be put into operation until you have carefully read all the instructions for use and installation, safety instructions and other information contained in this manual.** Lack of awareness can result in serious accidents – fire, electric shock, severe injury or even death. Keep this manual for future reference and review it every once in a while. **Also make sure that others who may use this device are properly instructed as well in order to ensure safe operation.**

As the main purpose of the electric drive is to open and close the enclosure, extra care is needed to avoid hazards to people, animals and items in the vicinity.

The manufacturer is not liable for any damage to the device or for any legal consequences of such damage, if the damage is caused by use that does not comply with the operating instructions. The MOOVER device complies with Government Regulation No. 176/2008 Coll., on technical requirements for machinery (Directive 2006/42/EC of the European Parliament and of the Council), Government Regulation No. 117/2016 Coll., on the assessment of conformity of products with regard to electromagnetic compatibility when placed on the market (Directive 2014/30/EC of the European Parliament and of the Council), Government Regulation No. 118/2016 Coll., on the assessment of conformity of electrical equipment intended for use within certain voltage limits when placed on the market (Directive 2014/35/EC of the European Parliament and of the Council). A declaration of conformity is issued for the device.

To ensure effective charging via the solar panel, we recommend that THE MOOVER is placed in such a way that the panel surface is perpendicular to solar radiation at the time of its greatest intensity. The most typical case of MOOVER installation is on the swimming pool enclosure. For the placement of THE MOOVER, choose the part of the enclosure that faces south, south-west or south-east. The device may also be installed on entirely west- or east-facing sides of the enclosure, but at the cost of a loss in energy yield of about 20%. The solar panel on the MOOVER is positioned horizontally with an inclination of 25°. In some installation areas with more pronounced biological exposure (surrounding trees, bushes, etc.), the panel's self-cleaning ability may decline over time and so regular maintenance is needed. The PV panel is affected by weather and environmental conditions such as air pollution, high or low temperatures and UV exposure. Neglecting maintenance of the PV panel will cause a loss of its output! The panel is cleaned to a degree by rain and wind, but these do not remove all the dirt from the panel surface and on the module the dust settles permanently. The result is permanent soiling that can only be removed with special products.

### **The most common type of dirt deposits:**

The tilt of the panel is not enough to ensure that it is completely cleaned of dirt by rain and wind. In urban environments, dust, grease and various chemicals deposit on the panel from exhalations; near fields and meadows, pollen, dust and bird droppings stick to the panel. When the solar panel gets soiled, use a soft clean sponge, always properly soaked in water with the addition of a few drops of a preferably neutral detergent or a mild soap solution. Other external parts of the MOOVER can be cleaned with common cleaning agents suitable for coated metal parts. CAUTION – Never clean the MOOVER device with pressurized water (risk of damage to the internal electronics). In winter, we recommend dismantling the entire MOOVER system to protect the solar panel from soiling and especially the battery from exposure to cold temperatures.

# Included with the Delivery

## - list



1 x MOOVER



1 x Adapter and power cord [2Z13-01-ST035]



1 x Remote control [2Z13-01-ST005]

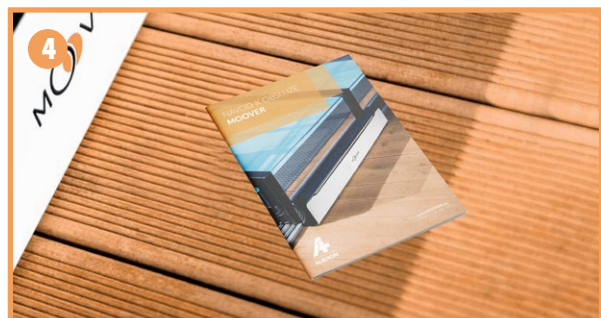

1 x Operating Instructions

**SYDNEY version [1SP11-01-028]**  
Screw 4x6.3x45 AN9051/A2  
– drill 5 mm, Allen key S=5

5



**Other versions [1SP11-01-025]**  
Screw 4x6.3x25 AN9051/A2  
– drill 5 mm, Allen key S=5

6



**Pads for SYDNEY [1SZ30-01-055]**

7



## Accessories

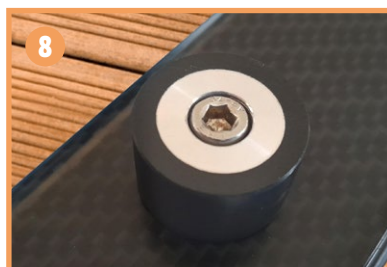

**Rubber stop – stacking system [2Z13-01-ST038]** 1 set = 4 rubber stops (number of sets according to the number of enclosure modules)

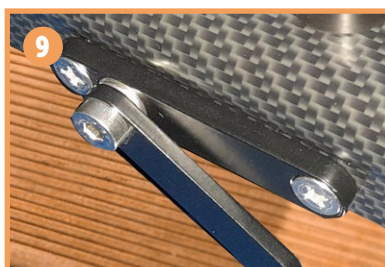

**Stacks – stacking system [2Z13-01-ST006]** 1 set = 2 stacks (number of sets according to the number of enclosure modules)



**Stacks [1SP11-01-044]** Screw 6.3x45 ISO 14586, drill 5 mm, TX30 (number according to number of stacks)

# MOOVER's Principle of Operation

## - opening and closing the enclosure

The MOOVER electric drive is used to open and close the pool enclosure. The movement of the electrically powered enclosure is controlled by a remote control. The remote control button operates in the **"dead man"** mode. This means that the MOOVER operator must press and hold the control button for the selected direction (opening or closing) for the entire travel of the enclosure. If there is an imminent collision, the enclosure is immediately stopped by simply releasing the button.

If the operator of the enclosure travel does not release the control button, the enclosure movement will stop immediately in its extreme position (mechanical stop on the enclosure rail) by triggering the control unit's surge protection. In this enclosure position and device control status (with the remote control button still pressed), the drive wheel of the device may slip. This can cause increased wear and tear on the tread of the wheel and a corresponding reduction of its service life.



### Automatically – using the MOOVER

Use the remote control for automatic movement.



### Manually – using human power

For manual sliding, the wing nut must be unscrewed to release the wheel pressure (see MOOVER Installation, Fig. on page 14) – we recommend dismantling the MOOVER if operated manually on a long-term basis (risk of wheel wear).

# Stacking System Operating Principle

## - opening and closing the enclosure

The stacking system aids automatic collection of the (individual and telescopically arranged) modules when the enclosure travels between its extreme positions. These correspond to positions with the enclosure fully open or fully closed. This system facilitates automatic movement of all enclosure modules between these positions (with the system in the ON position) and also easy disengagement of this arrangement (with the system in the OFF position).

If the latches of the individual modules are locked (system position ON), sliding the first (top) enclosure module will also automatically move all the remaining modules to the desired extreme position of the enclosure.

The system's OFF position allows access to the pool by simply manually pushing the internal enclosure module aside (thus disengaging it from the coupling system).

**If you do not have a stacking system installed on the enclosure by default, stacking bases and rubber stops must be installed on the individual modules** (see the chapter Installing the Stacking System on page 08).



The latches must be locked (=position ON) for the MOOVER to work properly.

# Preparation Before Installation

## - requisites

### Preparation of Tools for MOOVER Installation

Installation must take place in suitable weather conditions (no rain or strong winds, etc.) and there must be no persons using the pool during the installation.

 Drill	 Drill bits with diameters of 3.5 mm, 5 mm and 5.5 mm	 Allen key sizes 4 mm and 5 mm and TX30 stack screw attachment
 10-mm wrench for nuts	 Marker or other tool for marking holes	 Cleaning agents for the enclosure structure according to the enclosure manufacturer's recommendations – see page 2
 Tape measure or rule	 Goggles	 Gloves

**CAUTION!** When drilling, ensure that metal chips do not fall into the pool (e.g. use a pool cleaner to suck them out while drilling).



MOOVER



MOOVER

MOOVER

# Installing the Stacking System

## - stacking installation

For ALBIXON a.s. enclosures, this chapter does not apply to SYDNEY and Casablanca Infinity single-rail enclosures (in these the stacking system is already factory-installed). For enclosures of other manufacturers, do not install the stacking system on enclosures with an already factory-installed integrated stacking system.

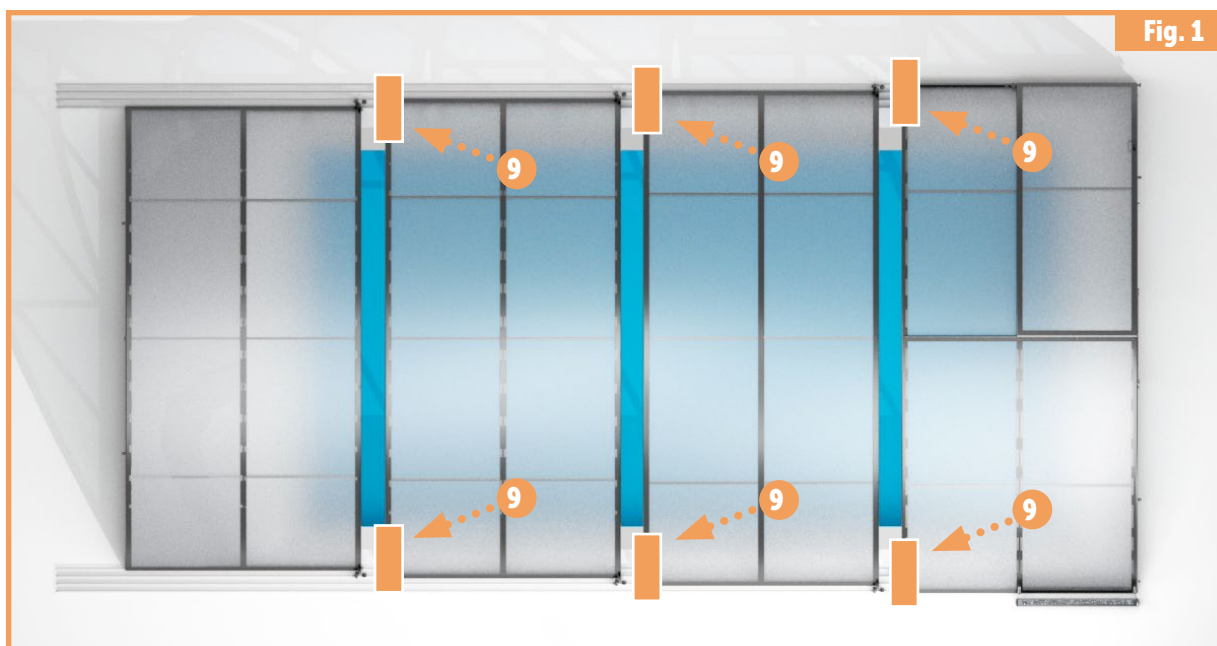

Fig. 1

The stacking base must be installed on both sides of all modules except the last (smallest) module. For easier and more precise installation of the bases, we recommend sliding all the modules off the pool and latching them.

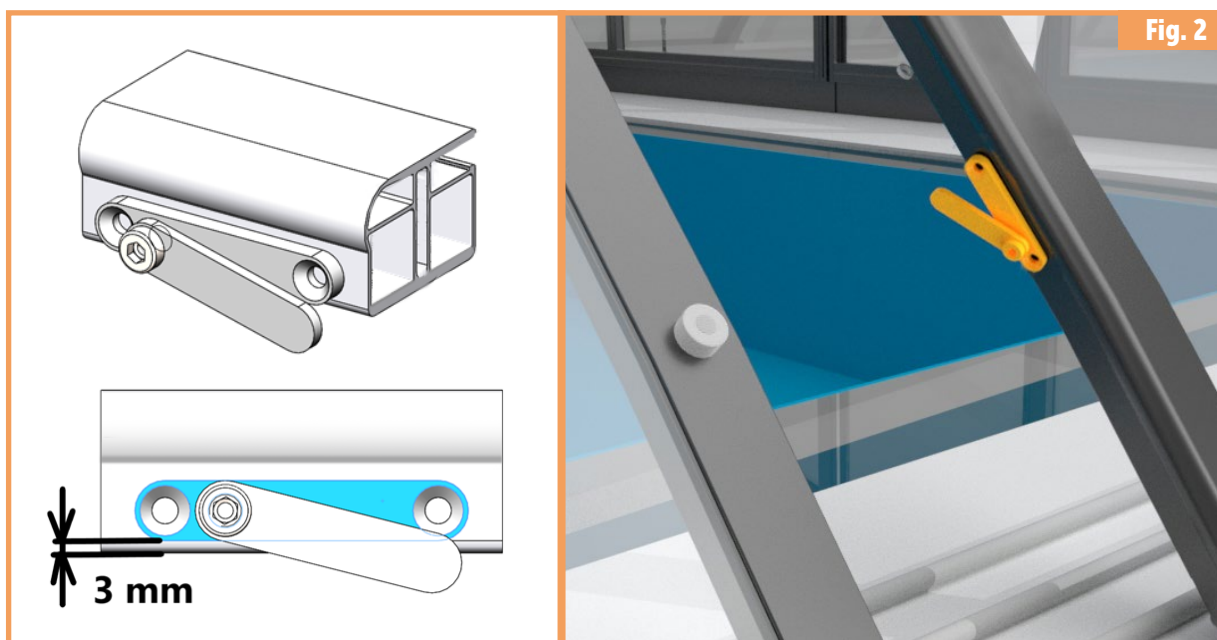

Fig. 2

Always place the stacking 3 mm from the bottom edge of the profile; see picture. It needs to be positioned on the enclosure within reach of manual control.



Fig. 3

Use the stacking base as a template to mark the holes to be drilled. Choose the point with regard to the height of the enclosure in your case and future comfort of use considerations.



Fig. 4

Mark two spots for drilling holes in the enclosure structure, on which you should then mount the stacking base.



Fig. 5

Pre-drill holes with a diameter of 3.5 mm in the marked places and then drill the final holes with a diameter of 5.5 mm. Depth of borehole 45 mm.



Fig. 6

Attach the stacking base to the holes and screw it to the enclosure structure using two 6.3x45 ISO 14586 screws (position 10 on page 3).



**CAUTION!** For ALBIXON a.s. enclosures, place the stack at least 100 mm from the bottom edge of the arch (applies to all types of enclosures except CASABLANCA INFINITY and SYDNEY enclosures).

For CASABLANCA INFINITY and SYDNEY enclosures (minimum heights), place on the arch at least 100 mm from the corner towards the centre of the enclosure (the joint of the arch and the leg).

For other manufacturers' enclosures, the position must be chosen so that it does not collide with the functional elements of the enclosure.

# Installing the Stacking System

## - installation of rubber stop

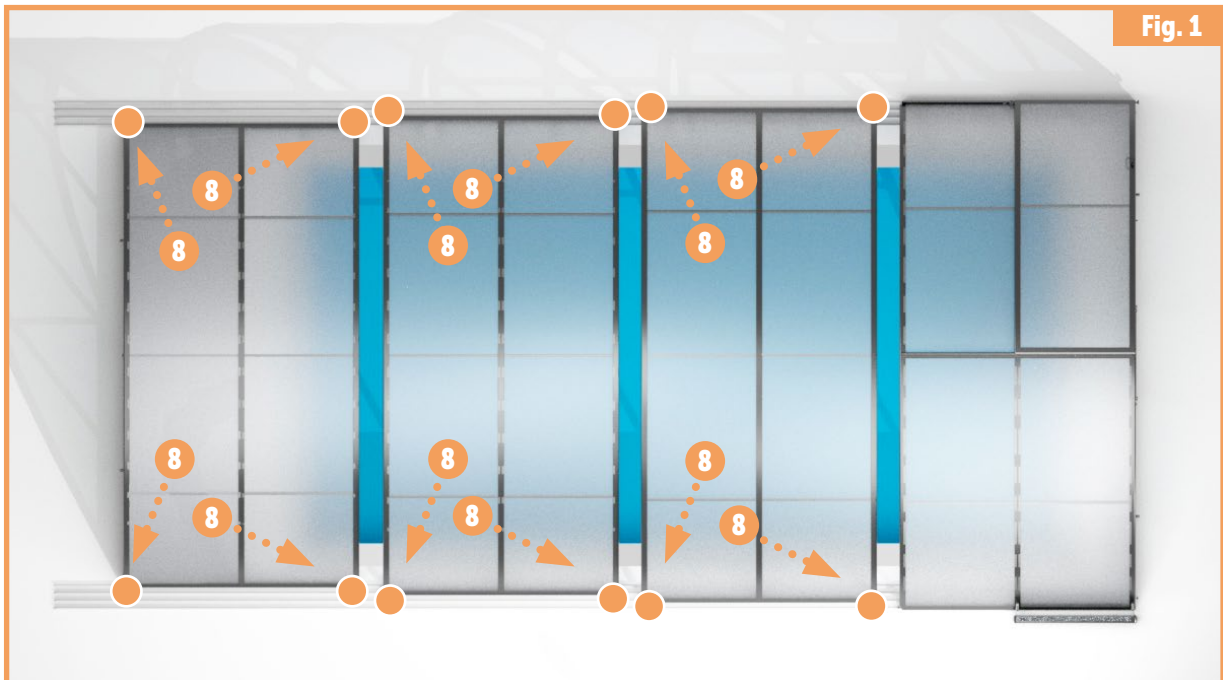

The stacking stop must be mounted on all modules except the first (largest). To install the stacking stops, the enclosure must be opened and latched.

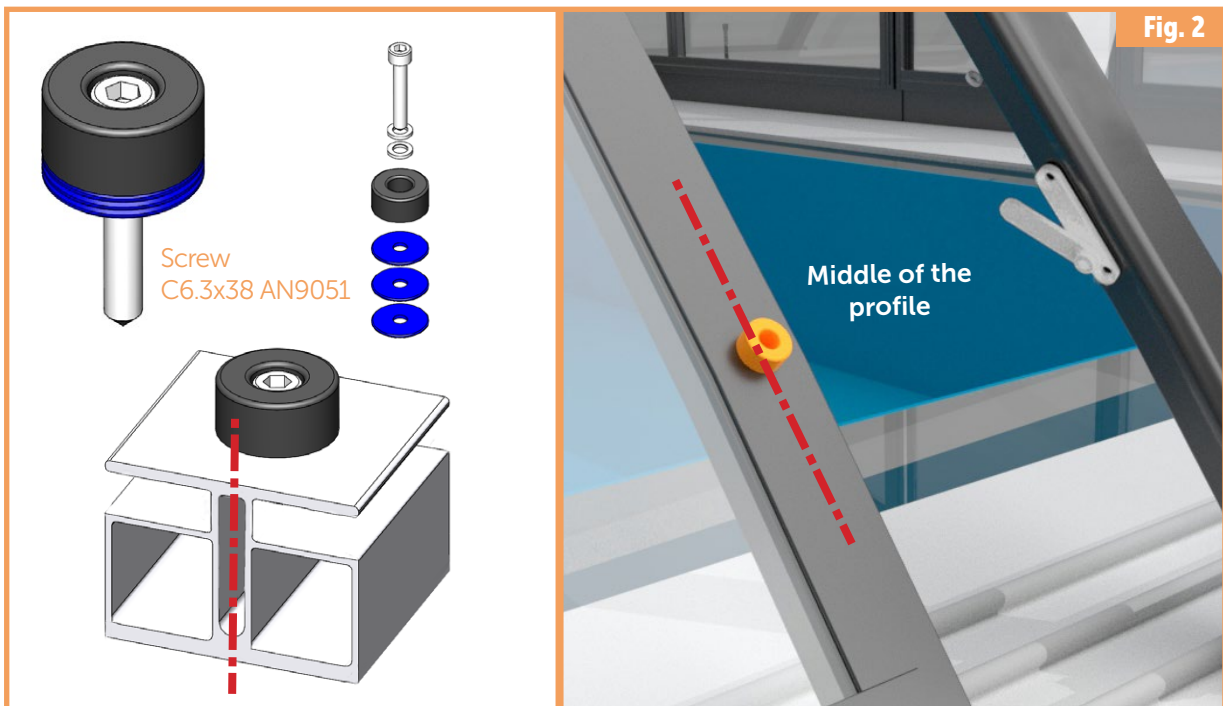

Always install the stop in the middle of the load-bearing profile (otherwise there is a risk of damage – cracking of the enclosure panels). The stop comes with three pads; see picture (blue). It is thus advisable to pad the rubber stop using these so that the lever does not lean out too much.

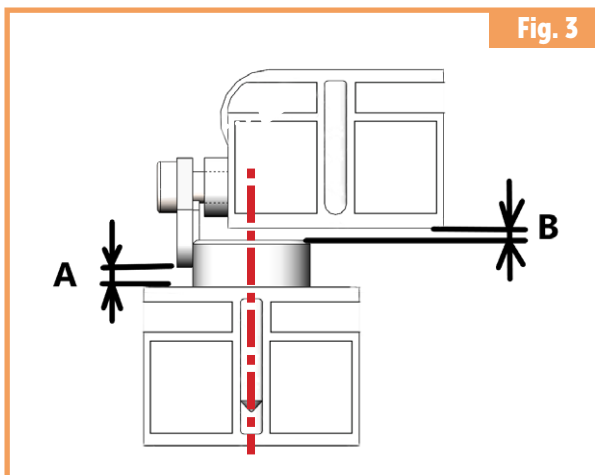

Fig. 3

B – Optimal 3 mm. | A – Optimal 3 mm  
**CAUTION!** If the dimension is smaller than these values, there is a risk of damage to the enclosure.



Fig. 4

Always mount the stop on each next module so that it is **on the same level as the marked part of the "latch" and in the middle of the enclosure profile**. Make sure that the enclosure modules are symmetrical on both sides.



Fig. 5

Mark this position and pre-drill a hole with a diameter of 3.5 mm and then 5.5 mm to a depth of 25 mm.



Fig. 6

Screw the rubber stop onto the enclosure structure using a C6.3x38 AN9051 screw.

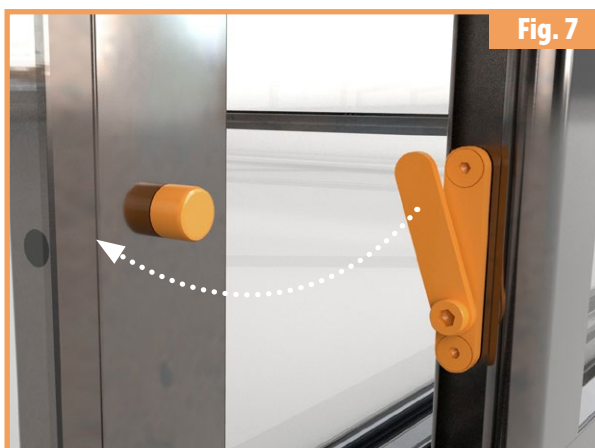

Fig. 7

Move the module with the stack to such a position that the stack is behind the stop (so that each module pulls the next one when closing the enclosure).



Fig. 8

Secure the stack in this position by tilting the latch towards the enclosure structure. **CAUTION!** After setting the stacking stop, check over the full length that there is no contact with the enclosure.

# MOOVER Preparation Before Installation

## - checks before installation

### Connecting the Adapter and Checking the Battery Status

Before the actual installation, MOOVER must be charged to full capacity (100% power status  )  
See the chapter LED Panel Animation on page 21.

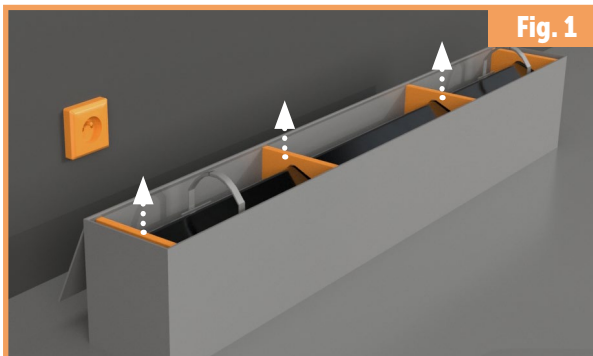

Fig. 1

Take the MOOVER in the box to the power socket and remove the "tabs".

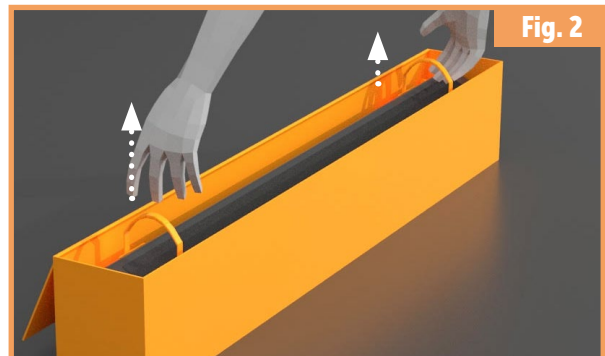

Fig. 2

Grasp the MOOVER by the straps and remove it from the box.

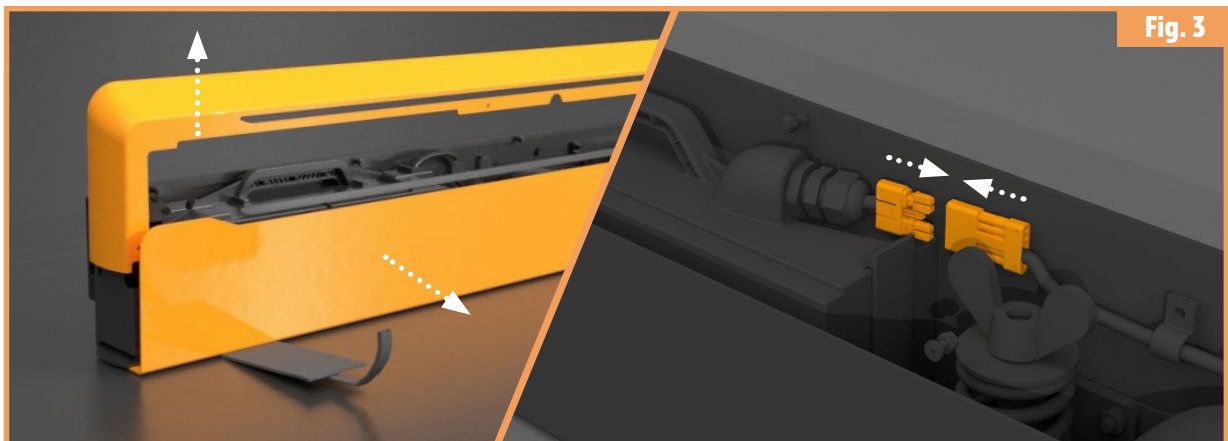

Fig. 3

Slide the top cover upwards and connect the power unit connector.

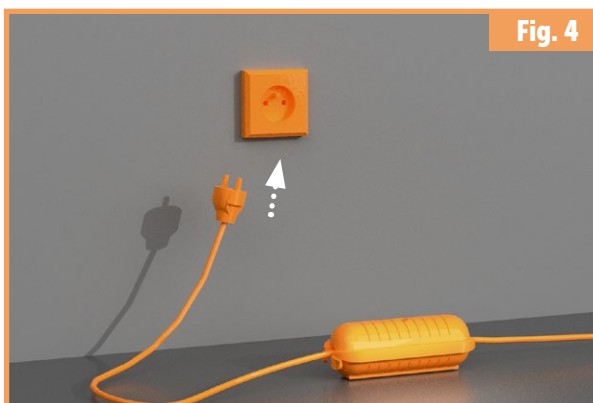

Fig. 4

Plug the power cord of the adapter into the mains.

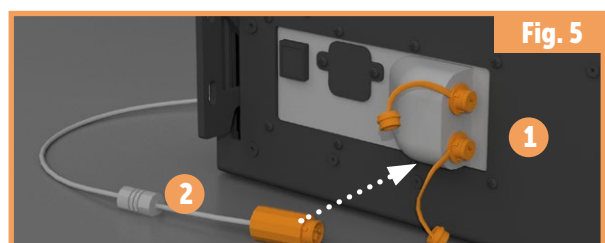

Fig. 5

Disconnect the cap and connect the adapter to the MOOVER. Either of the two connectors can be used. A second connector is available for the possible connection of an additional solar panel. After the MOOVER is connected to the charging cable, the LED panel shows the current battery charge status.

# MOOVER Preparation Before Installation

## - checks before installation

Fig. 6

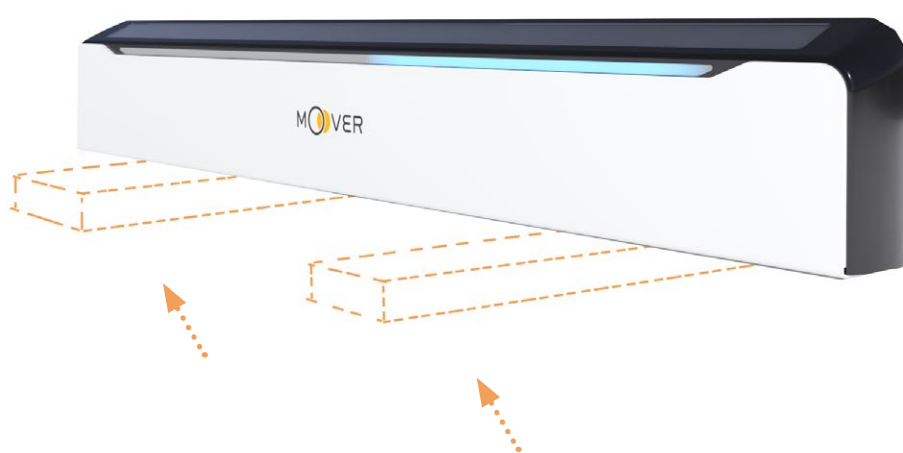

### Before proceeding with the installation, you must test the MOOVER's functionality.

Before the actual functionality test, the MOOVER must be placed on pads so that the wheel is in the air and the MOOVER cannot move unexpectedly on the pad. Then take the remote control and press any button. If the LED strip on the device flashes blue and at the same time you hear that the MOOVER has started, you can continue. If the LED strip does not flash, check the connector between the power unit and the control unit (see Figure 3 on page 12), or re-pair the remote control with the MOOVER device (see page 20). If problems persist, contact your device supplier.

Fig. 7



**Grasp the device by the straps** and put it on the installation spot. (Mount the MOOVER on the largest enclosure module – **never mount it directly on the sliding door**)

Fig. 8

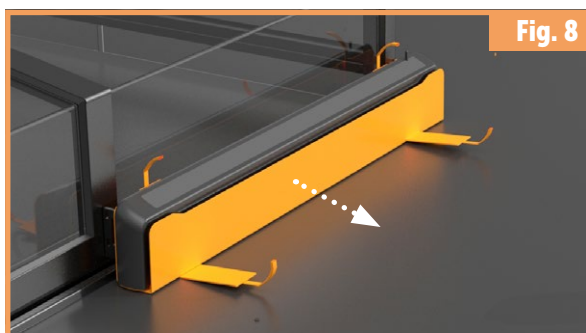

**Unfasten the straps with the padding** and **slide out the attached metallic front cover** (white cover with the inscription MOOVER) by approximately 2 cm.

# MOOVER Preparation Before Installation

## - checks before installation



**Slide the top cover upwards and disconnect the solar panel (beige) and LED panel (dark grey) connectors from the control unit.** CAUTION! – Be sure to pull at the connector, not by the cable. Otherwise this may damage the cable. Put the cover and the battery in a safe place to prevent damage during subsequent handling.

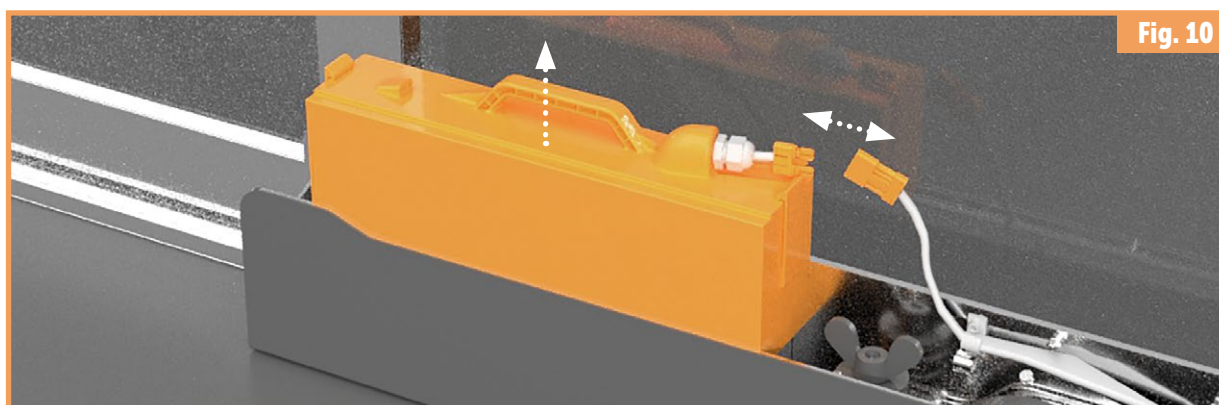

**Disconnect and slide out the power unit to reduce weight and for easier handling.** CAUTION! Disconnect the connector strictly by pulling at the connector body, not by the cable.



# MOOVER Installation

## - commissioning

Before installation, check that your existing enclosure slide works without any problems on a standalone basis (without THE MOOVER). **Only carry out the installation in suitable weather conditions (no rain or strong winds, etc.).** Inspect the enclosure surface at the spot where the template is about to be attached and clean and degrease as needed so that the adhesive tape of the template holds firmly after sticking. We also recommend that you lock the latch of the largest module on which the MOOVER will be installed so that it does not move around during installation.

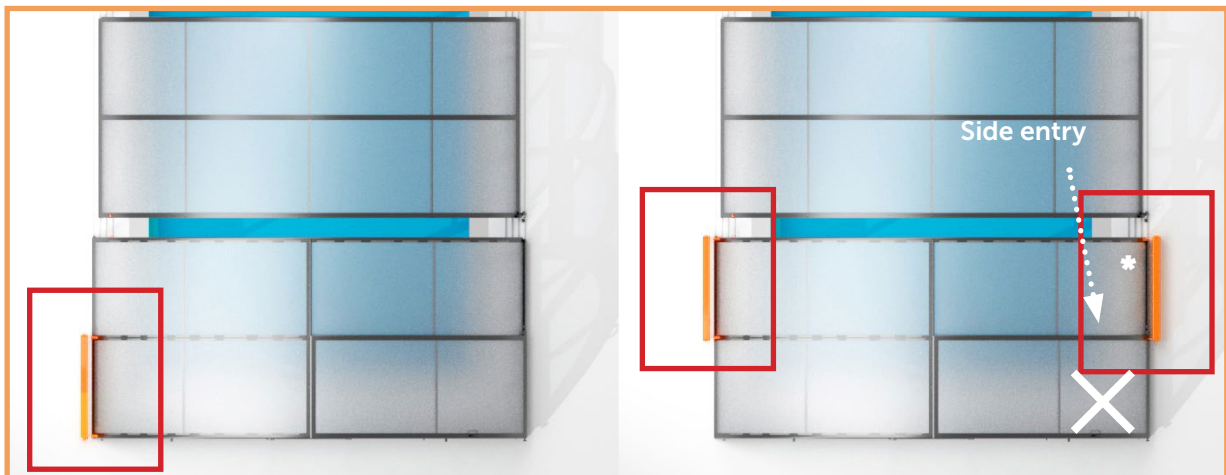

We recommend always mounting on the side of the module without the side entry. If the side with the side entry (\*) is chosen, it is necessary to install the MOOVER at the side entry on an auxiliary bracket (3A05-01-002), which is not included with the delivery. The electric sliding system cannot be mounted directly on the sliding door.

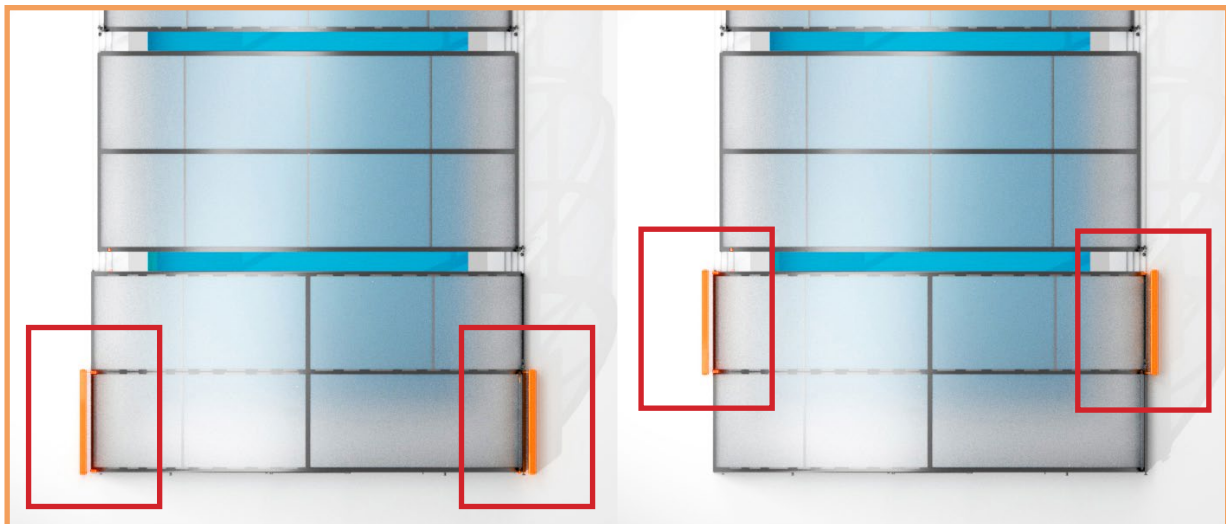

There are four placement options for enclosures without a side entry.

**CAUTION!** The MOOVER can be placed on both sides of the largest enclosure module except near the closed position of the sliding door.



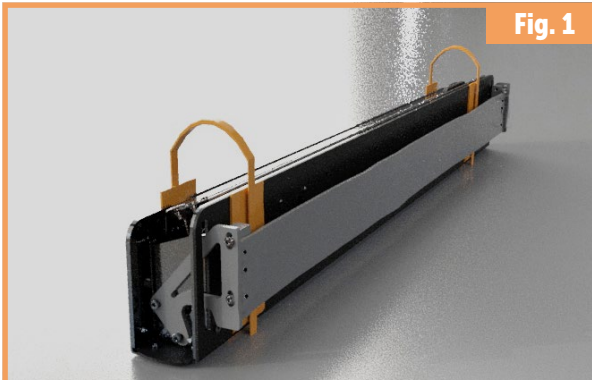

**Fig. 1**

Fasten the STRAPS with padding between the template and the MOOVER. **CAUTION:** Remove the padded straps only after completing the assembly (see Figure 15, page 19). The spacing between the MOOVER device and the floor surface should be 12 mm.

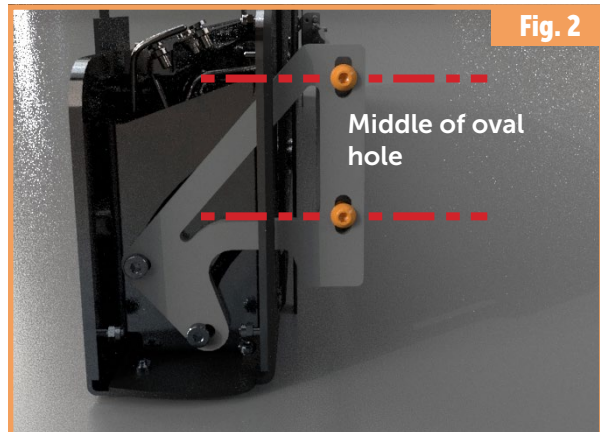

**Fig. 2**

Check that the bases of the bracket in the arms are fixed in the middle of the oval hole. If needed, reposition them to the middle and tighten.



**Fig. 3**

Tilt the two bracket arms towards the enclosure structure to the spot where the attachment will be made and align them so that the MOOVER is level. Peel off the protective tape from the adhesive tape on the template so that the template is ready for attachment. The MOOVER must be positioned in such a way that the holes for drilling into the supporting arches according to the marked holes in the template are centred on the profiles.

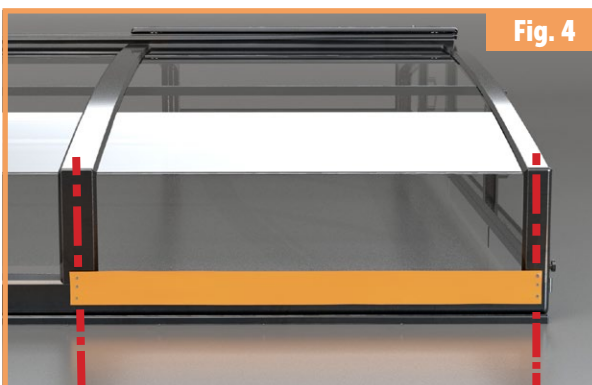

**Fig. 4**

Fix the template to the enclosure structure with adhesive tapes on both sides and peel off the adhesive tapes holding the template to the bracket arms. **CAUTION! Position the template in such a way that the drilled holes do not interfere with the enclosure running wheel.**

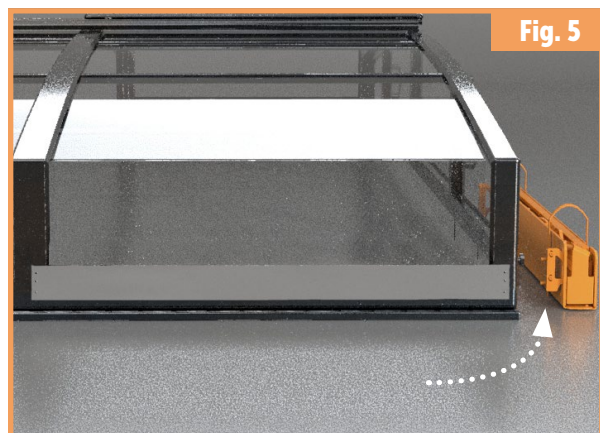

**Fig. 5**

Move the MOOVER aside so that it does not obstruct the assembly in the following steps. When moving, make sure that the template stays in its place.

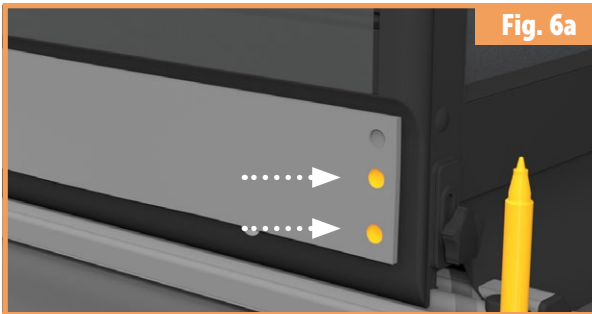

Fig. 6a

**Sydney ENCLOSURE:** Using the template, mark four points directly on the enclosure structure for drilling. We recommend verifying this step several times during the assembly procedure. **For SYDNEY enclosures, the MOOVER device is to be placed at least 100 mm from the edge of the module. CAUTION! Mark the two bottom holes.**

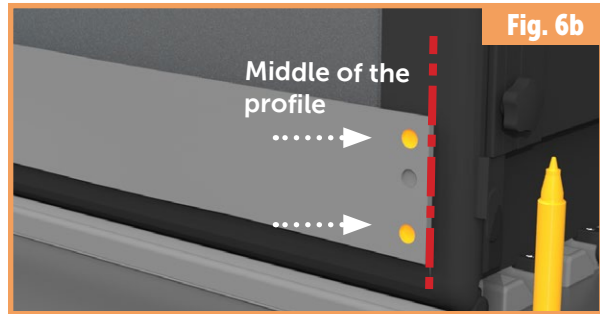

Fig. 6b

**Other enclosures:** Using the template, mark four points directly on the enclosure structure for drilling. We recommend verifying this step several times during the assembly procedure. **Always drill exactly to the middle of the aluminium profile; otherwise there is a risk of damage (cracking of the enclosure panels). CAUTION! Mark the top and bottom holes.**

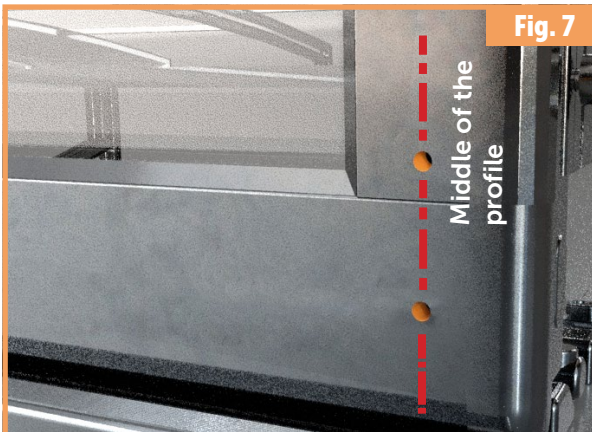

Fig. 7

Remove the template and verify that the marked spots are actually in the middle of the profile. Then pre-drill holes with a diameter of 3.5 mm and a depth of 30 mm.

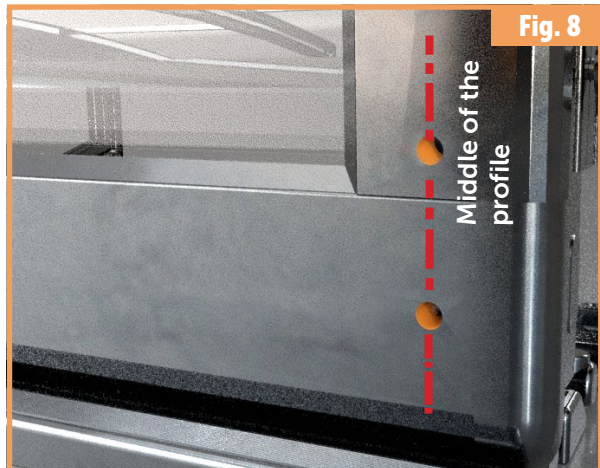

Fig. 8

Drill the final holes with a diameter of 5 mm.



Fig. 9

Unscrew the base from the arms of both holders.



Fig. 10

Screw the two bracket bases in the pre-drilled positions on the enclosure structure using the screw (position 5 for SYDNEY, position 6 for other enclosures). **CAUTION!** Check the correct orientation of the base – the oval hole must be facing upwards and the round hole downwards.

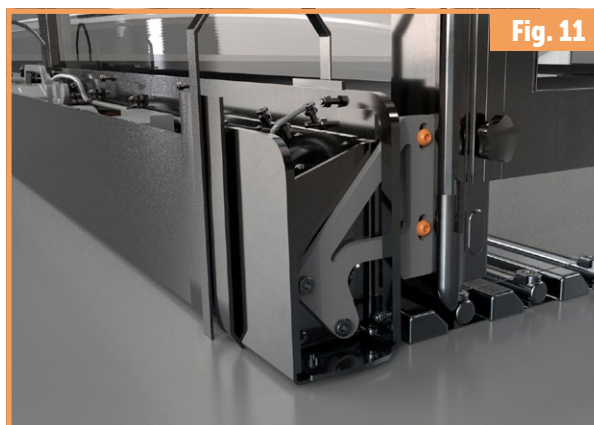

Fig. 11

Grasp the MOOVER by the straps with the padding and put it on the mounting spot again. **Screw the arms from the outside to the bracket bases.**

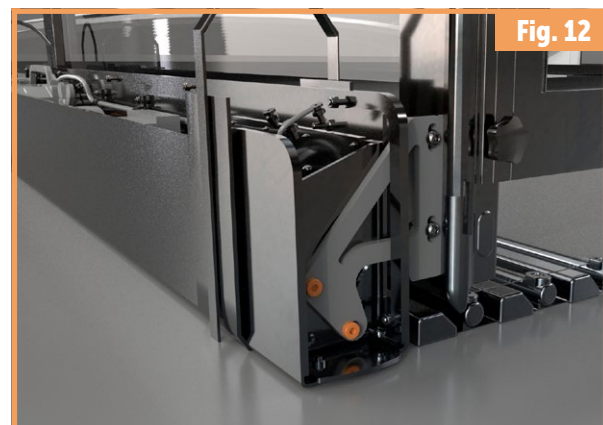

Fig. 12

**Tighten both arms of the bracket in the desired position.** **CAUTION!** Check visually that the arms on both sides of the MOOVER lean at the same angle.

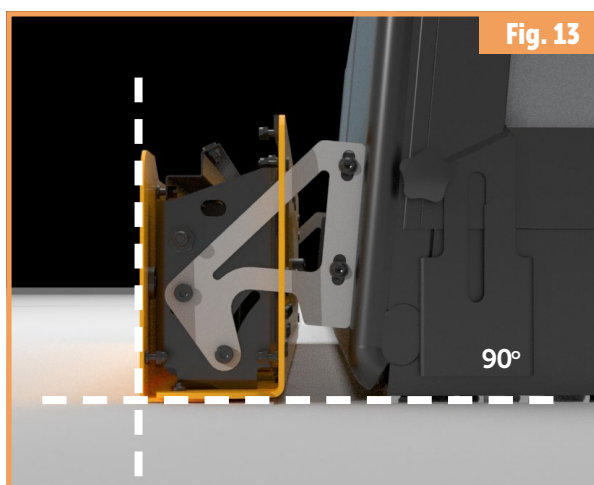

Fig. 13

Ensure that the MOOVER is fixed to the ground at an angle of 90°. The device must not be tilted in any way.



Fig. 14

**Tighten the wheel pressure by hand** to slightly loosen the pads under the MOOVER. Tighten until the MOOVER is raised above the level of the padding. **CAUTION!** In this step, **tighten the spring by slowly rotating it, not by forcing it to the stop.**

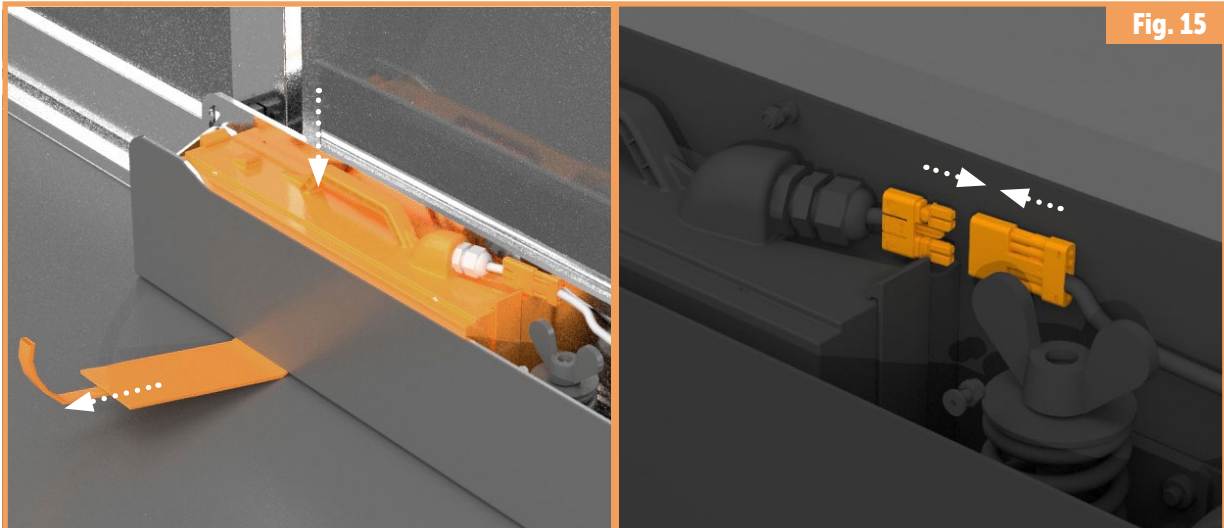

Fig. 15

Remove the straps and padding. Insert and connect the power supply unit.



Fig. 16

Check that the enclosure is unlatched, then use the remote control to move the MOOVER and travel the entire length of the track for verification (the button must be held until the slide reaches the end of its travel). If the MOOVER does not move after you have finished, remove the cover with the solar panel and go back to step 14 to adjust the wheel pressure. (for solutions to other possible issues, see "What to do if..." on page 24)

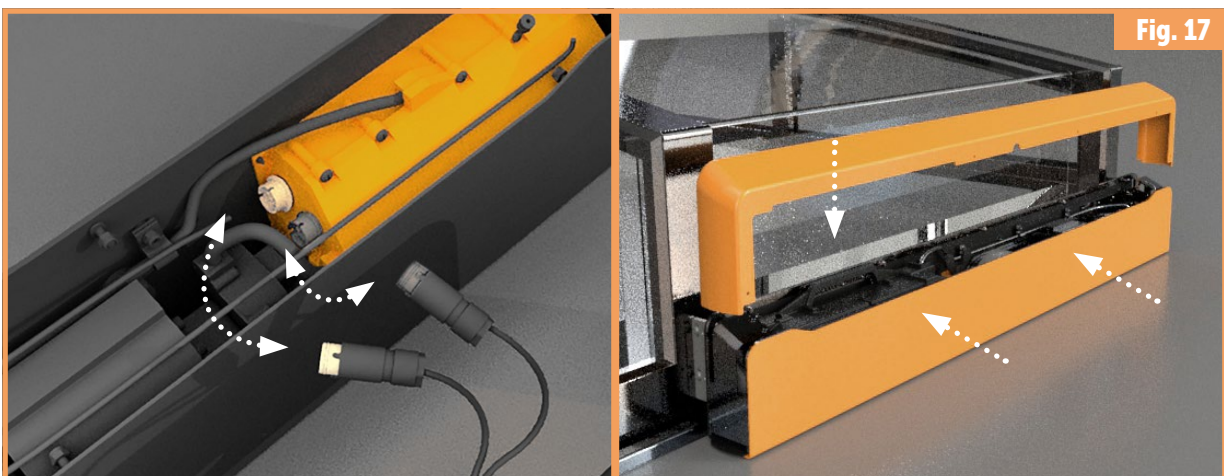

Fig. 17

Connect the solar panel connector (beige) and the LED panel connector (dark grey) to the control unit and then attach the cover with the solar panel and LED panel and close the front cover. All cables must be inside.

# Pairing the Remote Control

## - procedure

This procedure applies should the remote control that is supplied not work, or when purchasing a new remote control.

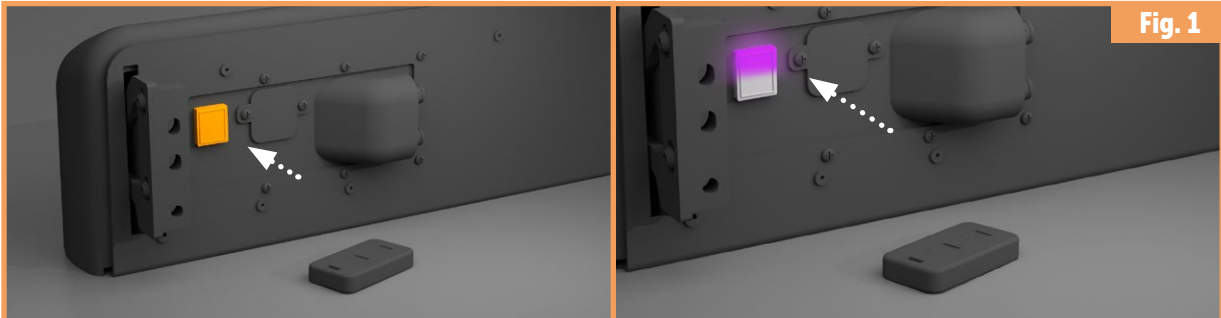

Hold down the button on the control board receiver until the purple LED on the board lights up.

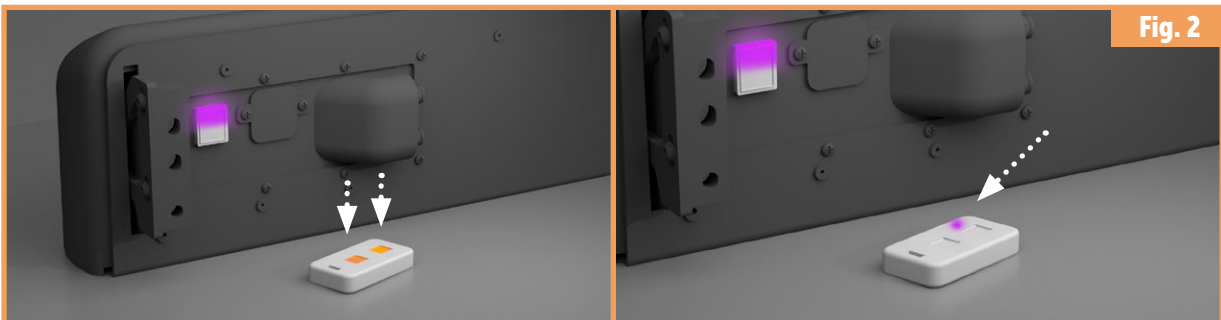

On the remote control, hold down both buttons until the purple LED on the remote control lights up.

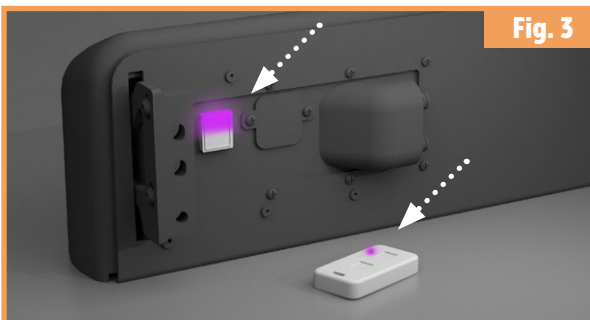

The moment both the transmitter and the receiver turn purple, the two units begin to pair. The whole process can take a few seconds.

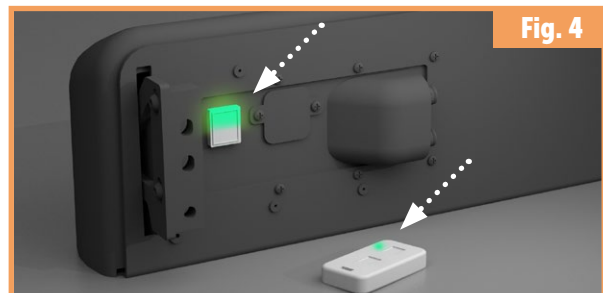

The transmitter and the receiver have a 20-second time window in which to pair. When the pairing is successful, the green LEDs will light up on both units. If not, repeat the procedure.

# LED Panel Animation

## - explanations

The different states of THE MOOVER are indicated by animations:

Description of activity	
1. Movement to the right	
2. Movement to the right with low battery	
3. Low battery (level 1)	
4. Very low battery (level 2)	
5. End of travel	
6. Power supply <10%	
7. Power supply <20%	
8. Power supply <30%	
9. Power supply <40%	
10. Power supply <50%	
11. Power supply <60%	
12. Power supply <70%	
13. Power supply <80%	
14. Power supply <90%	
15. Power supply <100%	
16. Power supply 100%	

# MOOVER Maintenance Instructions

## - necessary procedure

The procedures outlined in this manual are necessary to maintain the motion characteristics of the equipment and its long service life. These steps ensure the protection of the outer surfaces of the structure and all mechanisms of the device. Regular inspections of the travel must be carried out during the bathing season and also before reassembly. Measures must be taken immediately after a problem with the device is detected.

### How to carry out regular checks:

- ➔ Verify that no element of the device has been damaged.
- ➔ Verify that the existing sliding mechanism of your enclosure works on a standalone basis without the MOOVER.
- ➔ Check all screws. If necessary, tighten or replace defective ones (pay close attention in particular to the ones in the lower part of the MOOVER).
- ➔ Check the wheel visually for significant wear and lightly clean the accessible elements. (do not grease the wheels or any other parts with lubricant)
- ➔ Check that the track is clear for drive movement, with a clearance of at least 30 cm in all directions, and remove any obstacles if needed.



**Safe space:** For the movement of the MOOVER and the operator.



**Hazard area:** During installation, 50 centimetres around the MOOVER, and 30 centimetres around the MOOVER throughout its movement track when in use. This area must be kept free of personnel and obstacles that could hinder the movement of the MOOVER, such as rubble, branches, dirt, leaves, pine needles, etc.

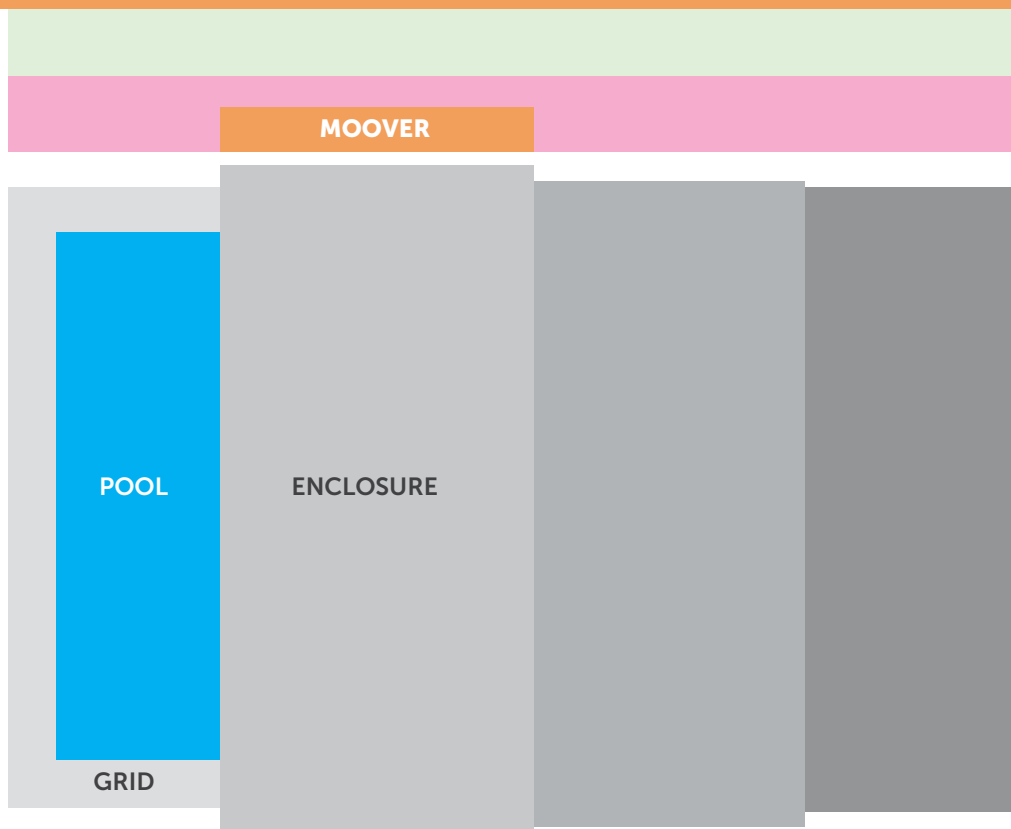

**CAUTION!** There is a risk of injury to persons moving in the hazard area. In the event of obstacles in the hazard area, there is a risk of damage to the MOOVER device.



# MOOVER Maintenance Instructions

## - necessary procedure

### Winterization:

- ➔ For the winter, dismount the device by loosening the wheel (Fig. 14 – MOOVER Installation, page 18) so that the bracket arms are unscrewed from their bases, and store until the next season in a dry environment at a temperature above 10 °C.
- ➔ It is advisable to keep the battery charged during winterization.

### Before reassembly:

- ➔ Check the battery status and recharge as needed. (you can see the battery status by checking the animation on the LED strip – see LED panel animation.)
- ➔ Verify that your enclosure travel works even without the MOOVER mounted.
- ➔ Ensure that the surface for the travel is smooth and free of obstacles.

### After reassembly:

- ➔ The wheel pressure needs to be adjusted.
- ➔ Use the controller to travel the entire length of the track (Fig. 16, page 19).

ALBIXON a.s. is not liable for any malfunction of the drive in the event of unauthorized changes to the drive settings or any of the safety features.

# What to do if...

## - troubleshooting

### The MOOVER starts to grind against the floor:

Loosen the bracket base screws (Fig. 11, page 18), remove the top cover and tighten the spring – this will raise the MOOVER. Then tighten the screws again and check that they are at the same height on both sides, and also check perpendicularity to the floor (see Figures 12 and 13, page 18).

### The wheel starts to slip:

Remove the top cover and tighten the wheel. Do it cautiously and gradually, with one turn of the wing nut at a time until the wheel starts to engage.

### The LED panel displays the "end of travel" animation before the end of the track is actually reached:

Check the condition of the rails and the track surface and remove obstacles if necessary. If the problem persists, the drive may be overloaded because of a crooked floor or rails. If that is the case, the wheel must be loosened (we recommend by 180°).

Loosen the wheel by turning the wing nut on the spring – always turn it by 180° at a time and continue to loosen in equal steps as needed.

### The wheel levitates:

Loosen the wheel as far as it goes and adjust the position of the base – to the down stop (see Fig. 11, page 18). Close the MOOVER and test the travel. Lower the arms inside the MOOVER (internal screws – see Fig. 12, p. 18). Close the MOOVER and test the travel. Now tighten the wheels (see Fig. 14, page 18).

MOOVER



# Detailed Specifications and Liability for Defects

## - specifications

Category	Property concerned	Value	Notes
<b>Dimensions</b>	Length	1157 mm	
	Width (without handles and external connectors)	80 mm	
	Width (with mounting handles)	110 mm	
	Height	163 mm	With retracted wheel.
<b>Weight</b>	Weight of THE MOOVER (with battery)	27 kg	
	Weight with packaging	30 kg	
<b>Electronics: power supply</b>	THE MOOVER's standby time (the value is only approximate – without the aid of the integrated solar panel)	Up to 800 hours	In ideal conditions and at 100% charge.
	Remote control standby time (the value is also approximate)	Two years	In ideal conditions.
	Maximum voltage in the system	18 V	Integrated solar panel circuit – the voltage depends on ambient conditions.
	Rated voltage of the main battery	12 V	
	Maximum voltage of the main battery	14.4 V	Only during charging.
	Capacity of the main battery	18 Ah	
	Maximum charging current of the integrated solar panel	7.5 W	
	Battery type (2 x battery – 18V 9Ah)	Pb	Dimensions: Length – 151 mm, WIDTH– 65 mm, Height – 94 mm, Height with connectors – 98 mm
	Charging adapter	18 V, 3.33 A, 60 W	
	INPUT	00 – 240 VAC 50/60Hz, 1.4A	
OUTPUT	18 VDC, 3.33 A, 60 W MAX.		
<b>Electronics: antenna</b>	Band	2.4 GHz	
	Range	Up to 15 m	Depending on ambient conditions.
	Maximum number of paired remote control transmitters	10	When another remote control is paired, the first paired remote control is automatically dropped.
<b>Drive</b>	Gearbox type	Auger	
	Motor output power	114 W-225 W	
<b>Safety features</b>	Current load limitation – software-based	-	Depending on firmware settings.
	Current load limitation – hardware-based	15 A fuse	
<b>Equipment protection</b>	IP coverage	IPX4	
<b>Operating Conditions</b>	Maximum height difference of the floor	8 mm	
	Minimum floor width from the edge of the enclosure (as opposed to the rail edge)	120 mm	

The conditions for liability for defects are governed by the warranty claim rules of ALBIXON a. s.

# Charging Process and Principle

## - instructions

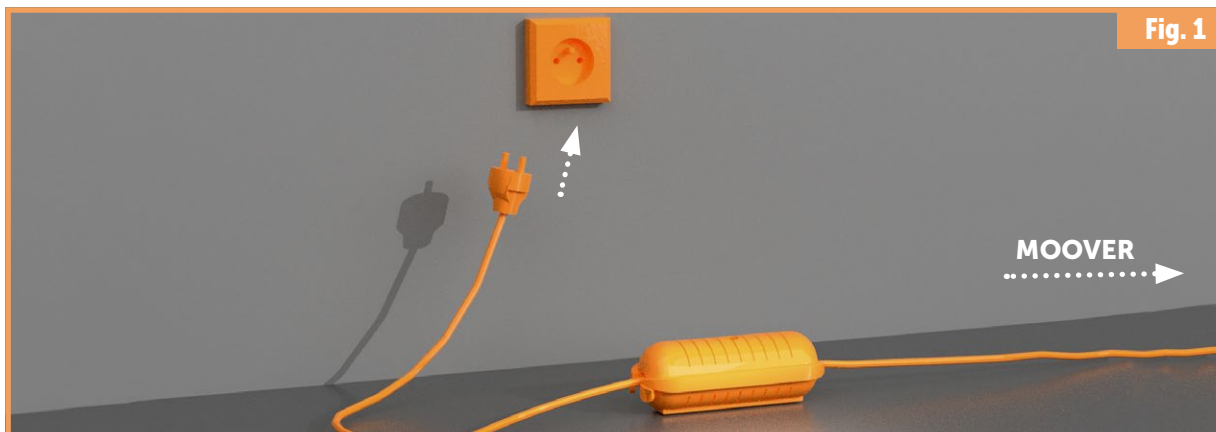

Connect the power cable to the adapter and plug it into the mains.

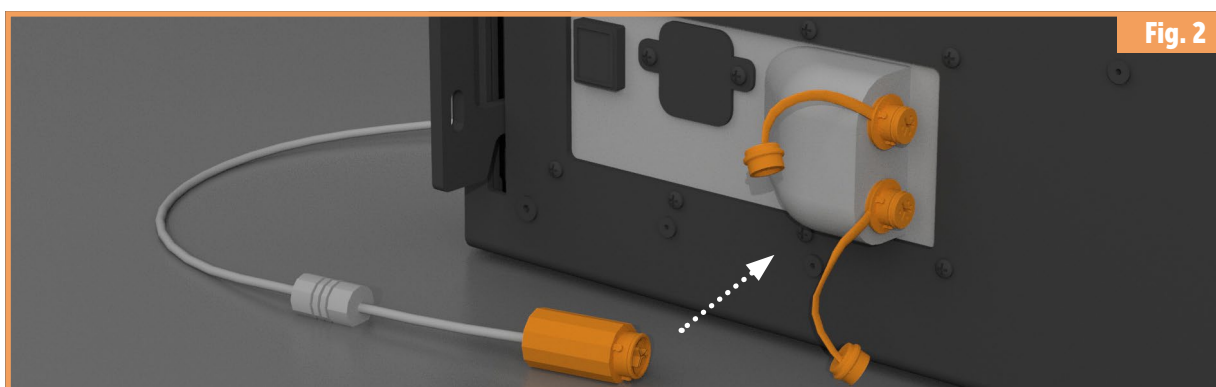

Disconnect the cap and connect the adapter to the MOOVER. Either of the two connectors can be used; the other is available for a possible external solar power supply. After the MOOVER IS CONNECTED, the LED panel shows the current status.



Charging indication by LED strip. For more information, see the chapter LED Panel Animation (page 21).

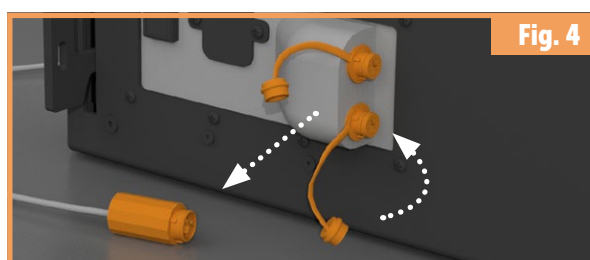

When the charging is complete, disconnect the adapter and attach the connector caps.

**CAUTION!** The power adapter must be placed as far away from the pool as possible.

# Replacing the Battery

## - instructions

For replacement, we recommend that you purchase batteries designed specifically for the MOOVER device from the original equipment dealer, or contact your equipment dealer for a complete replacement.

The MOOVER device contains a 2 × 12 V 9 Ah lead acid battery with dimensions 151 × 65 × 94 mm.

### Battery Disposal

We pride ourselves on being environmentally friendly. Therefore, we remind you that old and spent batteries do not belong in unsorted municipal waste, but should be delivered to collection points or the so-called take-back points, from which they go for reuse or recycling.



#### CAUTION!

When replacing the battery, both new batteries must be charged to the same 12 V and have the same capacity; otherwise there is a risk of damaging the control unit or fire in the MOOVER device.

**The batteries must not be short-circuited.**



MOOVER

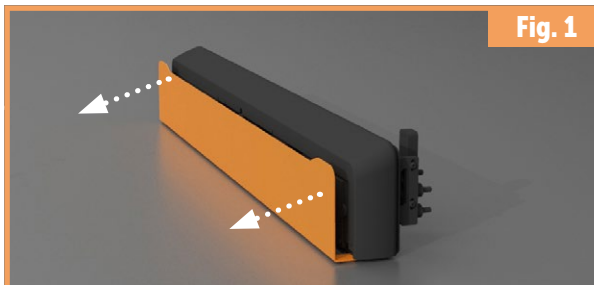

**Fig. 1**

Slide out the attached metallic front cover (white cover with the inscription MOOVER) by approximately 2 cm.



**Fig. 2**

Slide the top cover upwards and disconnect the solar panel (beige) and LED panel (dark grey) connectors from the control unit.

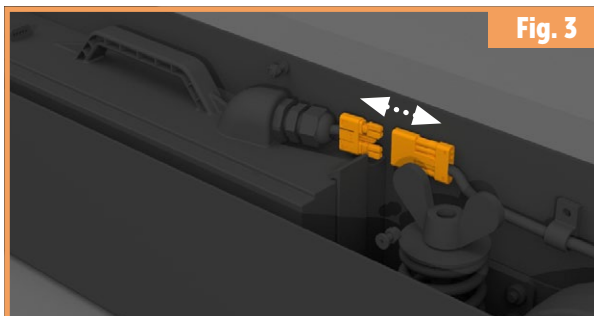

**Fig. 3**

Disconnect the connector leading from the battery to the control unit.

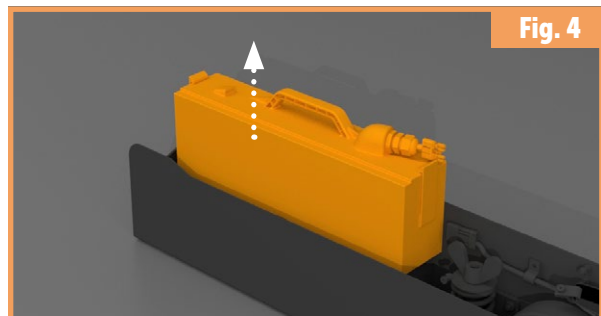

**Fig. 4**

Pull the power unit out upwards and place it sideways on an even surface.



**Fig. 5**

Release the lid of the power unit by slightly flipping the latches on the left- and right-hand sides of the power unit.

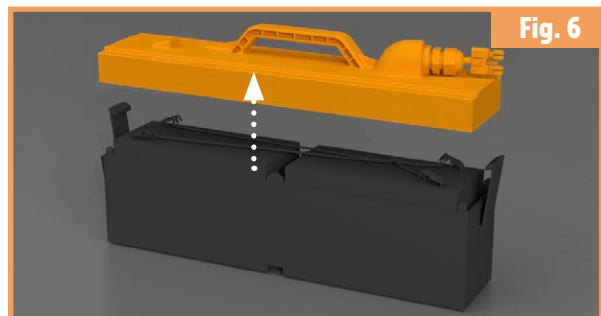

**Fig. 6**

Flip out the lid of the power unit and set it aside.

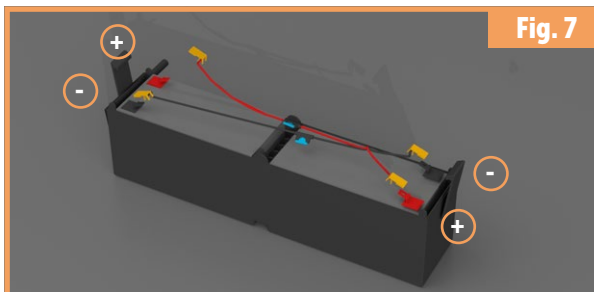

**Fig. 7**

Disconnect the battery connectors.  
CAUTION! Disconnect the connector strictly by pulling at the connector body, not by the cable.

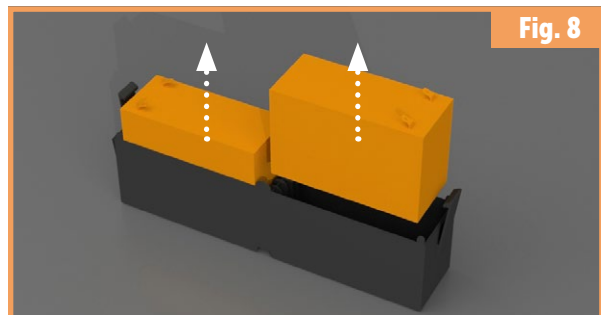

**Fig. 8**

Pull the batteries upwards out of the power unit pack.

To connect the new batteries, follow this procedure in reverse order – from Figure 8 to Figure 1.

# Replacing Fuses

## – instructions

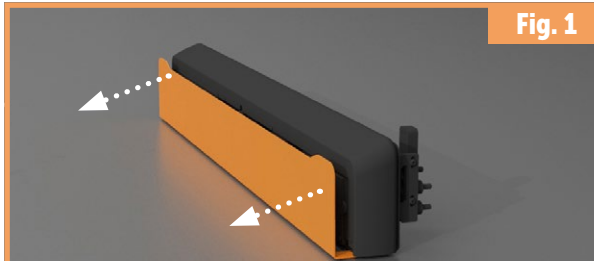

**Slide out the attached metallic front cover** (white cover with the inscription MOOVER) by approximately 2 cm.

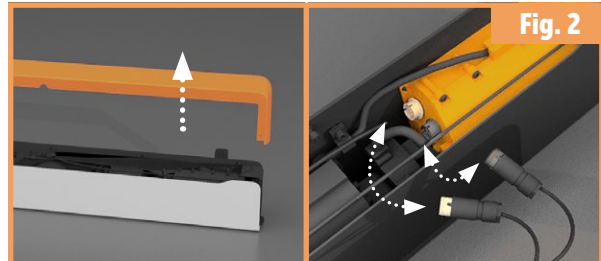

**Slide the top cover upwards** and disconnect the solar panel (beige) and LED panel (dark grey) connectors from the control unit.

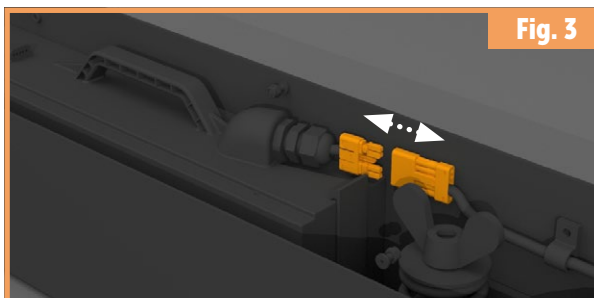

**Disconnect the connector leading from the battery to the control unit.**

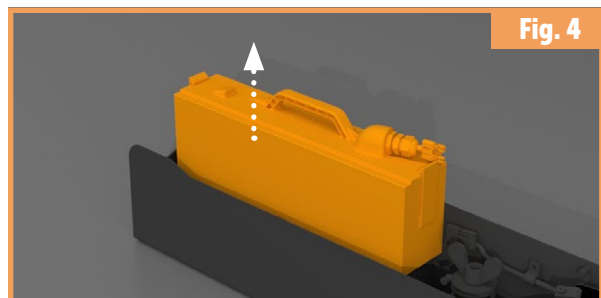

**Pull the power unit out upwards** and place it sideways on an even surface.



**Release the lid of the power unit by slightly flipping the latches** on the left- and right-hand sides of the power unit.

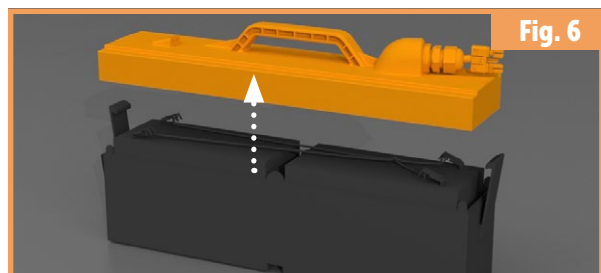

**Flip out the lid of the power unit and set it aside.**

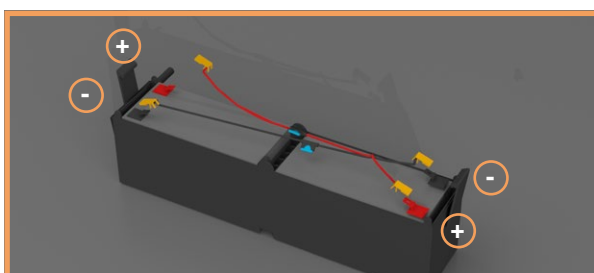

**Pull out the fuse and insert a new one (15 A blade fuse).** To return the power unit back to the MOOVER, follow the procedure in reverse order from Figure 7 to Figure 1.

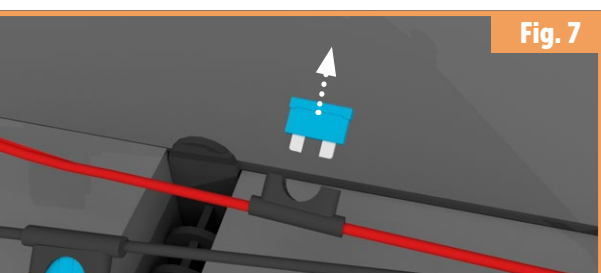



# List of Connectors

## - description

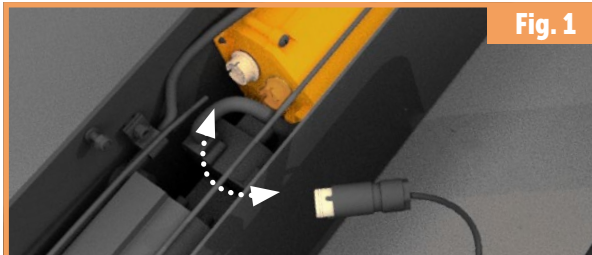

Fig. 1

Beige connector – solar panel.

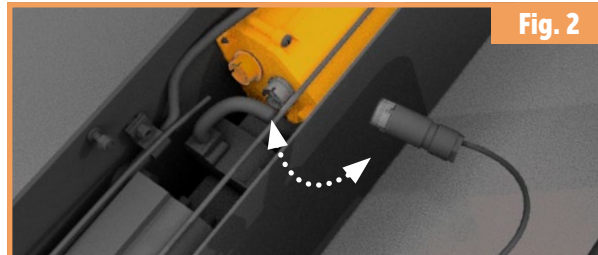

Fig. 2

Dark grey connector – LED panel.



Fig. 3

Connector for connecting the battery to the control unit.

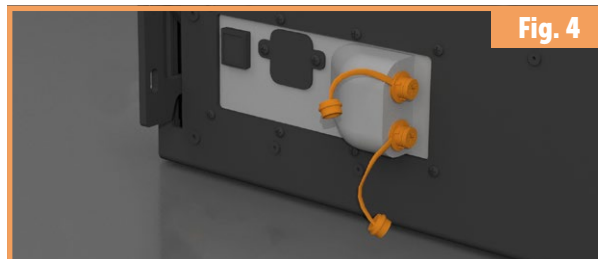

Fig. 4

Connectors for connecting the power adapter.



Fig. 5

Connector to connect the power adapter to the MOOVER.

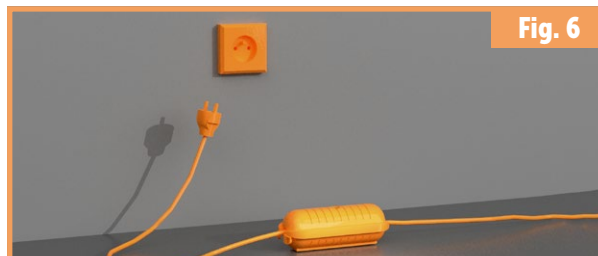

Fig. 6

Power adapter connector for 230 V.

Battery connectors. Pay attention to correct wiring:  
- red cable to the + connector (marked in red)  
- black cable to the - connector (marked in black)

Fuse used: fusible blade fuse 15 A

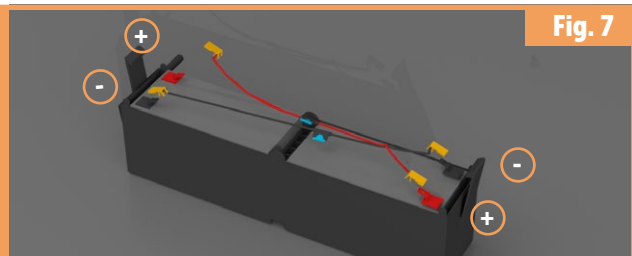

Fig. 7



**CAUTION!** Disconnect the connector strictly by pulling at the connector body, not by the cable.

# Preparing the Enclosure Before Using the MOOVER Electric Sliding System

- ➔ Unlatch all enclosure modules.
- ➔ Check that there are no obstacles in the track course that could cause problems during movement.
- ➔ The MOOVER operator steps back into the safe zone and from there can activate the device with the remote control.

## Using the MOOVER electric drive:

- ➔ Press and hold button 1 or 2 to activate the MOOVER device and the enclosure will start moving in its path (as soon as the button is released, the MOOVER stops).
- ➔ The direction of the movement of the MOOVER will be shown accordingly by the LED panel (see the chapter LED Panel Animation – page 21).
- ➔ When the enclosure reaches the end of the track in its movement, release the button on the remote control (if you don't do this in time, the MOOVER surge protector will trigger and stop the movement automatically) and lock the enclosure in the extreme position.



- 1 Button 1 – activates THE MOOVER and the enclosure starts moving to the right/left (depending on the side of the MOOVER installation).
- 2 Button 2 – activates THE MOOVER and the enclosure starts moving to the right/left (depending on the side of the MOOVER installation).



**W026**  
Warning; Battery charging



**W024**  
Warning; Crushing of hands



**M006**  
Disconnect mains plug from electrical outlet



**P010**  
Do not touch

The minimalist look, which matches all shades of enclosures, will become a design enhancement of your garden.



Thank you for using our products.



MOOVER

[www.MOOVER.eu](http://www.MOOVER.eu)

The photographs used in this manual are for illustrative purposes only.  
Typesetting and printing errors reserved.